



# Variheat system

**AA600/900**

Owner installation manual (1008516 issue 1)





## HEALTH AND SAFETY WARNING



As the dehumidifier embodies electrical and rotational equipment, ONLY competent persons should carry out any work on this type of machine.

(SEE GUARANTEE)

### Variheat system, AA600/900 Owner installation manual

#### CONTENTS

<b>HEATH AND SAFETY WARNING</b> .....	<b>4</b>	<b>4.0 AFTER INSTALLATION</b> .....	<b>51</b>
<b>1.1 WARNINGS</b> .....	<b>5</b>	<b>4.1 MAINTENANCE</b> .....	<b>52</b>
<b>1.2 REFRIGERANT TYPE AND INSTALLED LOCATION</b> .....	<b>7</b>	<b>4.2 CIRCUIT DIAGRAMS</b> .....	<b>53</b>
<b>1.3 FEATURES OF THE VARIHEAT RANGE</b> .....	<b>9</b>	<b>5.0 DATA SHEET</b> .....	<b>58</b>
<b>1.4 HOW TO USE THE VARIHEAT</b> .....	<b>10</b>	<b>5.1 LPHW HEATING DATA - VARIHEAT WITH STANDARD AIR HEATER</b> .....	<b>59</b>
<b>1.5 TOUCHSCREEN USER INTERFACE</b> .....	<b>11</b>	<b>5.2 LPHW HEATING DATA - VARIHEAT WITH UPGRADED AIR HEATER (WHERE MODEL NUMBER INCLUDES +EC LPHW)</b> .....	<b>59</b>
<b>1.6 DATA ENTRY</b> .....	<b>17</b>	<b>6.0 DIMENSIONS</b> .....	<b>60</b>
<b>2.0 USER SETTINGS</b> .....	<b>18</b>	<b>7.0 VARIHEAT CONFIGURATIONS</b> .....	<b>65</b>
<b>2.1 ADVANCED SETTINGS</b> .....	<b>27</b>	<b>8.0 WARRANTY CONDITIONS</b> .....	<b>68</b>
<b>2.2 REMOTE ACCESS TO THE VARIHEAT TOUCHSCREEN</b> .....	<b>34</b>		
<b>3.0 INSTALLATION</b> .....	<b>37</b>		
<b>3.1 SITING, MACHINE LOCATION</b> .....	<b>38</b>		
<b>3.2 FRESH AIR AND EXHAUST AIR</b> .....	<b>40</b>		
<b>3.3 PLUMBING INSTALLATION</b> .....	<b>41</b>		
<b>3.4 ELECTRICAL CONNECTIONS</b> .....	<b>43</b>		
<b>3.5 ELECTRICAL INSTALLATION</b> .....	<b>44</b>		
<b>3.6 VOLT FREE TERMINALS AND REMOTE ACCESS</b> .....	<b>46</b>		
<b>3.7 NETWORK CONNECTION</b> .....	<b>48</b>		
<b>3.8 BMS CONNECTION (BUILDING MANAGEMENT SYSTEM)</b> .....	<b>49</b>		
<b>3.9 OPTIONAL REMOTE SENSOR BOX</b> .....	<b>50</b>		



### HEALTH AND SAFETY WARNING



This appliance can be used by children from eight years and above and persons with reduced physical, sensory or mental capabilities or lack of experience and knowledge if they have been given supervision or instruction concerning the use of the appliance in a safe way and understand the hazards involved. Children should not play with the appliance. Cleaning and maintenance shall not be made by children without supervision.

This machine is classified as “NOT ACCESSIBLE TO THE PUBLIC” and therefore should be located in a machine room and serviced by qualified personnel.

Disconnect from the mains supply and wait three minutes before removing panels and commencing work on this machine.

This guide provides information needed to install and operate the product effectively. Please ensure you read this manual and use the correct installation and operating procedures.

**This manual is intended for installers and users. Read the entire manual before using the heat pump. Awareness of the correct operating procedure for the machine and any safety devices is important, to avoid damage or injury.**

## 1.1 WARNINGS

Important safety information is contained in this manual and marked on the heat pump.

**Please read and follow all safety advice.**

**The refrigerant used in this heat pump is R454C. This refrigerant is environmentally friendly, but safety instructions must be strictly adhered to.**



**The WARNING sign denotes a hazard. It calls attention to a procedure or practice, which if not adhered to could result in injury. Warning signs and procedures must be complied with.**

**If a refrigerant leak is suspected stop using the heat pump and contact Dantherm Group UK service. [service.department@dantherm.com](mailto:service.department@dantherm.com)**

**Take the following precautions in order to avoid any danger:**

### REFRIGERANT SAFETY:

**This heat pump contains R454C refrigerant. Work on the refrigeration system, repair and disposal must be carried out by appropriately qualified and registered engineers competent with A2L refrigerants.**

**Repair, service and disposal must be carried out in the UK and EU by F-Gas registered engineers.**

Completely de-gas the refrigerant before any brazing is performed. Brazing can only be carried out by technicians trained to EU 517/2014.

Appropriate safety measures and risk assessments must be taken before work commences.

**Do not attempt to work on the equipment by yourself. Consult the qualified engineer undertaking the work to establish all requirements before work commences.**

### ACTIONS TO AVOID (OPERATION AND HANDLING):

Be especially careful when handling the heat pump, not to cause any damage that may result in leakage of the cooling circuit.

Do not use means to accelerate the defrosting process or to clean, other than those recommended by the manufacturer.

Do not pierce or burn.

### IN CASE OF FIRE:

Toxic fumes may occur in the event of fire. You must leave the room as quickly as possible in the event of fire.

### LOCATION REQUIREMENTS:

The heat pump contains R454C refrigerant so the following location requirements must be fulfilled:

**The heat pump must be kept away from sources of fire or naked flames.**

The heat pump must be installed, operated and stored where the floor area is larger than the minimum requirement., see section 1.2.

The heat pump shall be stored in a room without continuously operating ignition sources (for example: open flames, an operating gas appliance or an operating electric heater).

Keep the ventilation openings clear of obstruction during operation.

Do not use or store combustible gas or liquids near the heat pump.

**Check if there are any local regulations, which you must comply to, when installing or storing the heat pump.**

**Be aware that refrigerants may not contain an odour.**

Installation must be carried out by competent people, in accordance with this manual.

### **INSTALLATION:**

Read the instructions before installation, use and maintenance.

If R454C gas leaks during the installation process, stop the installation immediately and call the service centre.

If a repair is required, please contact the nearest after-sales service centre.

To avoid over heating or over cooling of pool water check and set the temperature on the control panel.

The heating performance can be improved by insulating the flow and return pipework.

It is recommended that a cover is used on the swimming pool to reduce heat losses.

### **ELECTRICAL SAFETY:**

Mains power isolator should be out of reach of children.

After a power cut, when the power supply is restored, the heat pump may start up without warning.

Electric storms can damage electronic equipment. Ideally the heat pump should be switched off at the mains.

Installation must be carried out by competent people, in accordance with this manual.

### **HEAT PUMP MALFUNCTION:**

**WARNING:** Isolate heat pump electrically and wait 3 minutes before removing panels or entering heat pump.

Any sign of abnormal operation such as water dripping should be reported immediately to the installer. If in doubt or if advice is required contact the Service support team on telephone +44(0)1621 856611 (option 4).

### **MAINTENANCE:**

Isolate the power supply of the heat pump and wait 3 minutes before cleaning examination or repair.

Please clean this machine with household detergents or clean water. NEVER use petroleum spirit, thinners or any similar fuel.

Check bolts, cables and connections regularly.

### **BACKWASH:**

When performing a routine backwash care should be taken to prevent water passing through the heat pump in the reverse direction or at a rate which exceeds the maximum recommended water flow rates indicated in the data sheet [section 5.0] as this may cause damage to the heat pump water condenser or flow switch.

## 1.2 REFRIGERANT TYPE AND INSTALLED LOCATION

This heat pump contains R454C, which is an environmentally friendly refrigerant with a GWP (Global Warming Potential) of 146. R454C has the safety in use classification of A2L, being low toxicity and lower flammability. In practical terms it is very difficult to ignite an A2L refrigerant, but this classification requires a risk assessment to be undertaken for the possibility of refrigerant being released by accident into an area connected to the heat pump, considering the application, location of components, and the installed refrigerant charge. This installation guidance can form the framework for such a risk assessment for the installation.

All flammable refrigerants will not ignite if the concentration level in a room stays below their lower flammability limit (LFL). British standard BS EN 378 and European standard EN378 define requirements to remain far below the lower flammable limit in case of accidental leakage. By choosing the location as dictated by (BS) EN378-1 (latest version) the probability of forming a flammable atmosphere can be eliminated. Please refer to the minimum area for each product and the interpretation below regarding locations of heat pump and swimming pool. This information is provided as a guide only and does not supersede the regulations or health and safety requirements.

## INTERPRETATION

Please refer to the installation situations below for how to apply the minimum area stated above.

**As the pool hall and the plant room are linked through the duct work they are considered to be one area:**

The pool hall and plant room combined must exceed the minimum area requirement shown below.



MODEL		AA600	AA900
Refrigerant charge	R454C kg	*1.8	1.85
Minimum area	m <sup>2</sup>	*31.0	32.7
Notes	Assumed worst case for access category: a - general access and location class: 1 - mechanical equipment in occupied space; both as defined in line with (BS) EN378-1 (Latest version) section 5.1 table 4 and section 5.3 Minimum Area is calculated in line with section C.2 on EN378-1 (Latest version) (calculation C.2) *TBC		

**DISPOSAL:**

Repair, service and disposal of redundant heat pumps must be completed by authorised technicians. It is illegal to allow refrigerant gases to escape to air.

Do not attempt to work on the equipment by yourself. Improper operation may cause danger.

	<p>Do not use means to accelerate the defrosting process or to clean, other than those recommended by the manufacturer.</p>
	<p>The heat pump shall be installed, operated and stored in a room without continuously operating ignition sources (for example: open flames, an operating gas appliance or an operating electric heater).</p>
	<p>Do not pierce or burn.</p>
	<p>Be aware that refrigerants may not contain an odour.</p>
	<p>The heat pump shall be installed, operated and stored in a room with a floor area larger than <math>Xm^2</math>, where X is the "minimum area" shown in section 1.2 and section 5.0.</p>

	<p>The heat pump must be kept away from sources of fire or naked flames.</p>
	<p>Repair and disposal must be carried out by F-Gas registered engineers.</p>
	<p>Completely de-gas the refrigerant and purge the refrigeration circuit in line with FGAS regulations or national standards applicable to A2L refrigerants before any brazing is performed. Brazing can only be carried out by technicians trained to EU 517/2014.</p>



### 1.3 FEATURES OF THE VARIHEAT RANGE

The Variheat range consists of two models: 600 and 900. This manual covers the Variheat AA models, all purpose designed and built for swimming pool use, to provide heat pump dehumidification, heat recovery and optional fresh air ventilation. The recirculated air flow increases across the range, from 2000m<sup>3</sup>/h for an AA600 to 2500m<sup>3</sup>/h for an AA900. All Variheat models are supplied as packaged air handling units with an integral control system and a 3.5" touchscreen controller.

Variheat AA models offer the following features and functions:

- Robust chassis and construction specifically designed for a swimming pool environment
- Ventilation of the pool hall by main supply fan
- Optional fresh air module for automatically regulated introduction of fresh air using a dedicated exhaust fan and damper, set to provide a pool hall negative pressure
- Heat pump dehumidifier incorporating heat recovery
- Integral control system complete with PLC, sensors and 3.5" colour touchscreen, providing automatic control of:
  - Humidity
  - Air temperature
- Comprehensive configuration, operation and fault status
- Fully controlled LPHW air heater battery (AA+LPHW models only)
- Air filtration
- Optional features

For duct connections and LPHW pipework positions and sizes, please refer to drawings elsewhere in this manual.

The Variheat range can be supplied with many air outlet configurations, see configuration drawings for versions available. Spigots are provided for connection to ductwork. Versions with a bottom outlet main supply fan include an adapter to facilitate connection to floor ducting.

All Variheat AA models contain a heat recovery heat pump dehumidifier that is automatically controlled to remove unwanted humidity from the swimming pool hall. The heat recovery will contribute significantly towards the hall heating requirements. The system is optimised for a swimming pool environment and will provide efficiencies upwards of 250%.

All Variheat models have a main recirculating fan and is ready for connection to supply air ducting and return air ducting. All models use efficient, direct drive fans, either constant flow or EC speed controlled.

The optional fresh air module includes an additional, smaller, exhaust air fan, with dampers and is ready for connection to exhaust and fresh air ducting.

The optional negative pressure module includes the exhaust fan and dampers only, for installations where the make-up fresh air is introduced by other means.

All Variheat AA+LPHW models are fitted with a fully controlled air heater when connected to a low pressure hot water (LPHW) system. The output of the standard heat exchanger is rated at an LPHW flow temperature of 80°C (see data sheet on page 58). As an option, all Variheat models can be factory fitted with a larger air heater to provide the same output at 60°C as the standard air heater has at 80°C, to be used with renewable technology heat sources and condensing boilers that provide lower LPHW flow temperatures. Provision is made for the LPHW heat source to be initiated by the Variheat control system. The LPHW heat source is not included.

The optional electric air heater module includes air heating elements, with heating capacities ranging from 6kW to 18kW depending on model, in lieu of the LPHW air heater.

All Variheat AA models are fitted with pairs of "volt free" terminals that provide an interface for heat source and setback control, as well as remote monitoring/control of the unit. See section 3.6 Volt free terminals and remote access for a full list of these terminals.

1.4 HOW TO USE THE VARIHEAT

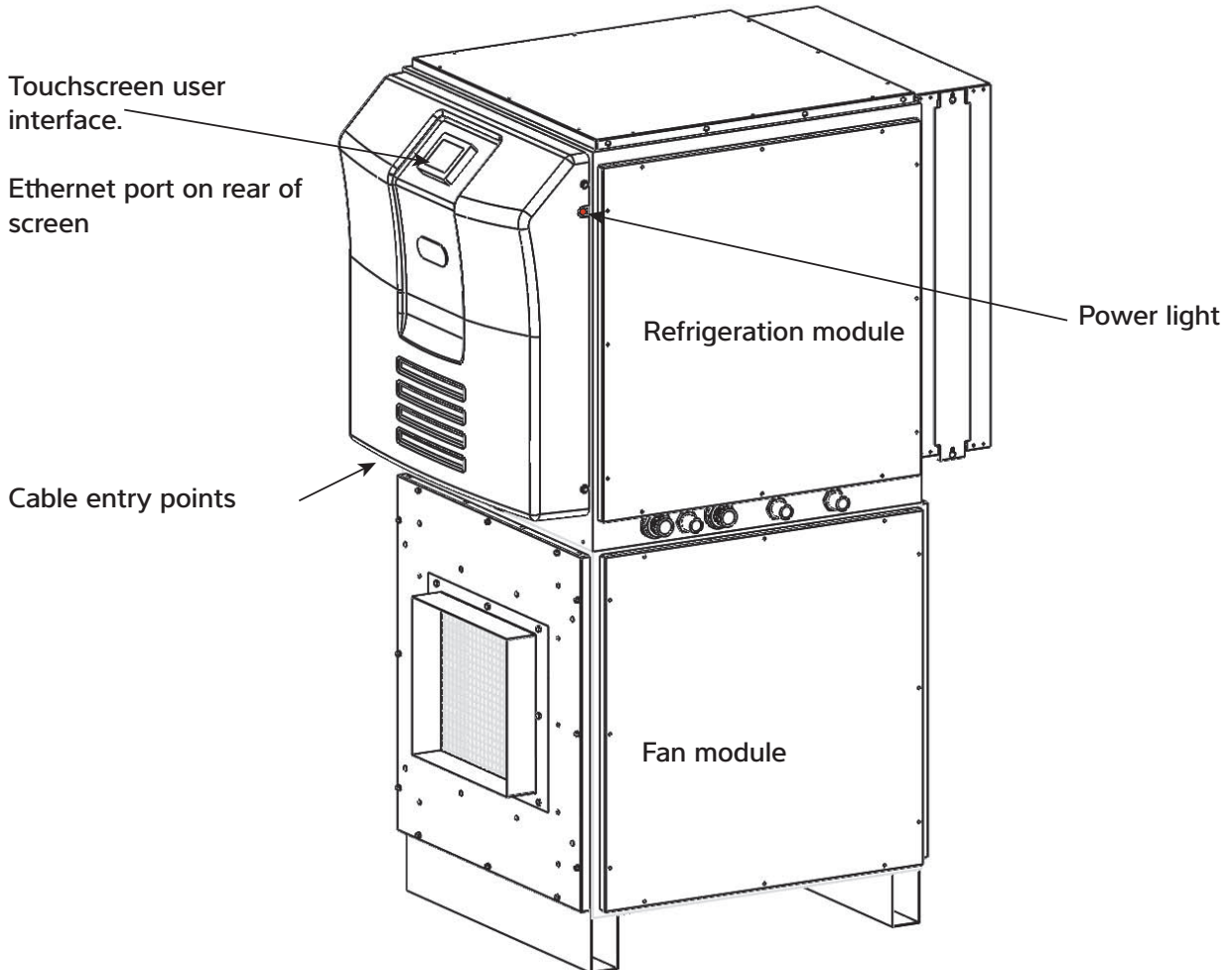

**Power light** – when illuminated red, power is connected to the Variheat.

**Caution** – the Variheat system remains powered and live. Ensure the Variheat is isolated from the power supply before any servicing or electrical work commences. When unlit, power is disconnected but remote interfaces connected to the Variheat from other systems may still be live.

**Ethernet port** – for connection to a local area network. (See page 48.)

**Touchscreen user interface** – display of operating condition and access to settings. (See page 11.)

For installation options see section 3.0.

## 1.5 TOUCHSCREEN USER INTERFACE

The Variheat is controlled by an integral controller with a touchscreen user interface. All the settings of the Variheat are available via the touchscreen.

Coloured buttons and parameters with a white background can be modified, except where locked by the User Security settings. Grey buttons and parameters with a grey background cannot be modified. (See page 24.)

**If the screen is blank, touch once to activate.**

### Home screens

These two screens display current operating conditions and main controls. Functions on the home screens can be modified if allowed by the User Security Mode settings. (See page 24.)

#### First home screen



Pressing the **+** button shows the second home screen. Pressing the home button returns to the first home screen.

#### Second home screen



FIRST HOME SCREEN

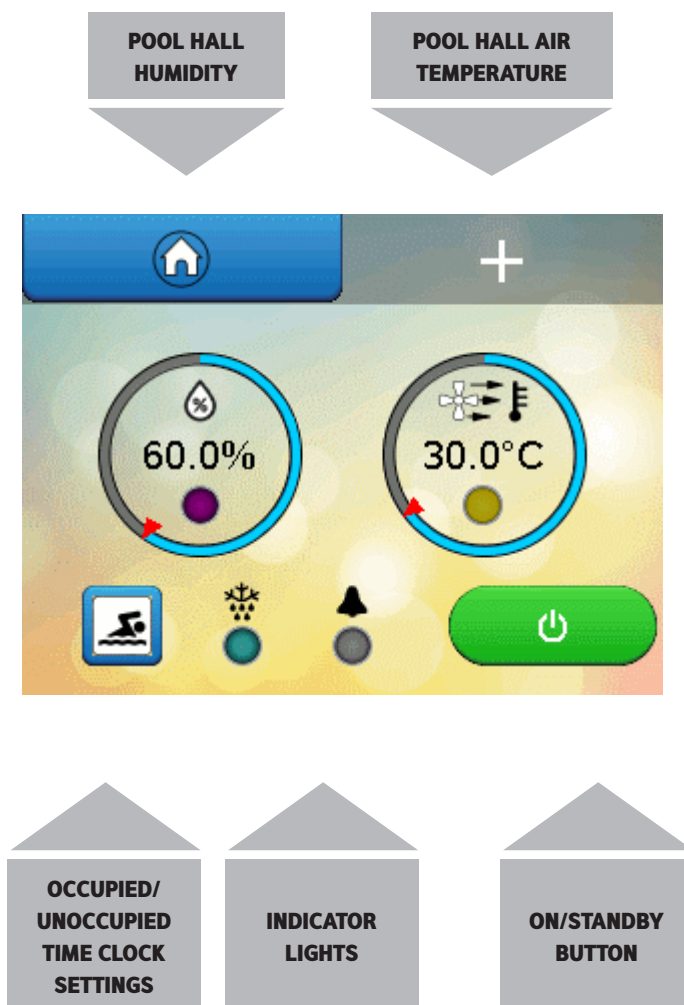

1. Pool hall relative humidity (%RH)

Number shows current measurement. Outer ring shows current measurement (blue bar) in relation to current setting (red arrow). Press the centre to change humidity setting.

Key to lights

Purple (flashing) – waiting for compressor delay timer to elapse.  
 Purple (solid) – dehumidification operating (compressor running).

2. Pool hall air temperature (°C)

Number shows current measurement. Outer ring shows current measurement (blue bar) in relation to current Occupied mode setting (red arrow). Press the centre to change temperature setting.

Key to lights

Yellow (solid) – air heating via LPHW operating (AA+LPHW models only).  
 Blue (solid) – free cooling operating (if optional fresh air module is fitted).

3. Swimming icon

Press to access time clock settings. The swimming icon shows that the Variheat is in the Occupied mode. A red cross indicates that the Variheat is in Unoccupied mode.

Functions on the first home screen can be modified if allowed by the User Security Mode settings. (See page 24.)

## LIGHTS AND STANDBY SWITCH

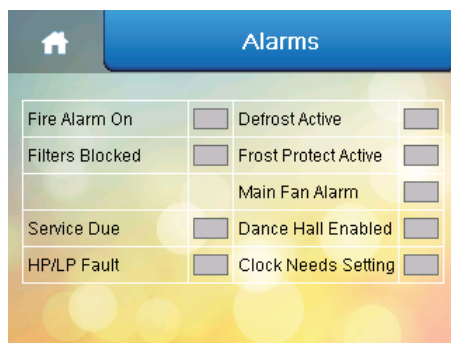

### Indicator lights

Pressing this area when an alarm is active displays the "Alarms" screen.

### Defrost light

Light blue (solid) – defrost is active. Defrosting is a normal function to remove ice from the heat recovery surfaces, which may be required when the pool hall air temperature drops below 20°C.  
 Dark blue (solid) – frost protection is active. (See page 48.)  
 Light blue and dark blue (flashing) – defrost and frost protection are active.

### Alarm light

Red (solid) – fault with the refrigeration system.  
 Pink (solid) – main fan fault or blockage.  
 Orange (solid) – fire alarm is active.  
 Purple (solid) – clock reset required.  
 Purple (solid) + 'S' – service is overdue. Contact the Dantherm Group to arrange servicing of the Variheat.

There can be more than one alarm. All alarms should be investigated. (See page 17.)



### Standby switch

Green and white – ON.  
 Variheat is powered and operating according to the control system settings.

Red and white – user Standby.  
 Variheat is powered but not operating. The Variheat has been put into Standby via the user touchscreen. See caution below. To enable the Variheat, press the red touchscreen button.

Orange and black – remote Standby.  
 Variheat is powered but not operating. The Variheat has been put into Standby via the remote On/Off control interface. See caution below. To enable the Variheat, change the remote interface from Off to On.

Red and black – user and remote Standby.  
 Variheat is powered but not operating. The Variheat has been put into Standby via the user touchscreen AND the remote on/off control interface. See caution below. To enable the Variheat, press the red touchscreen button AND change the remote interface from Off to On.

There is a ten second delay before the Variheat starts.

Caution: in all Standby modes, the Variheat system remains powered and live. Ensure the Variheat is isolated from the power supply before any servicing or electrical work commences. See power light see page 10

Following a power interruption the Variheat will either remain in Standby or attempt to restart automatically, according to the user setting. See page 29. Screen settings.

SECOND HOME SCREEN

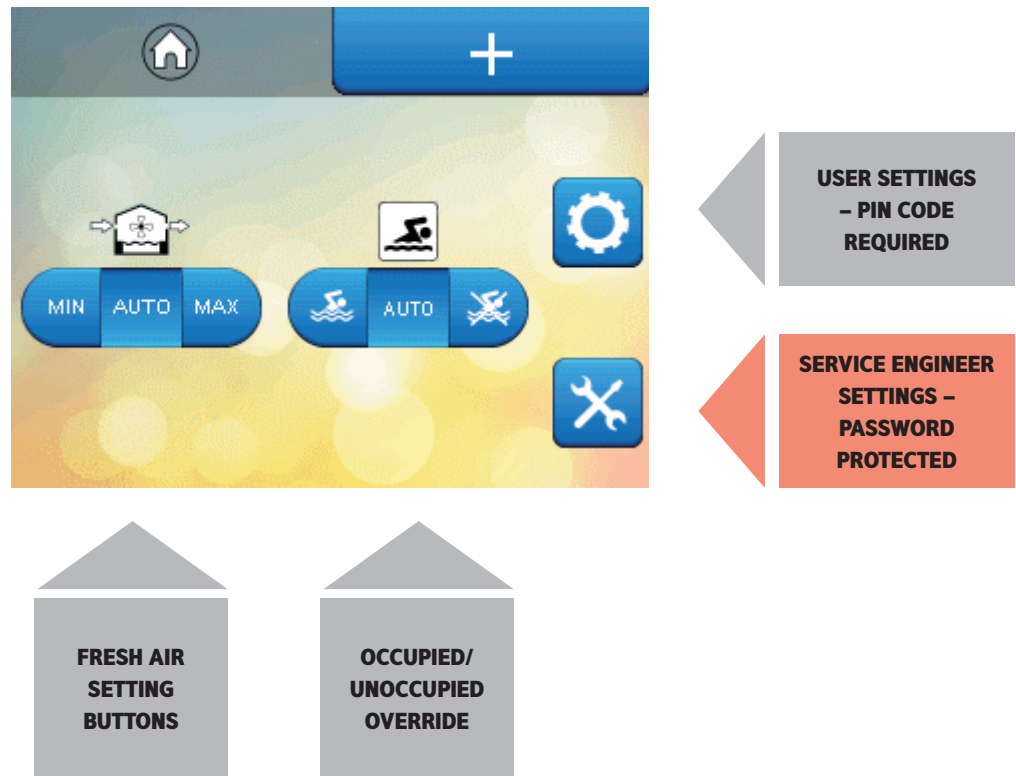

**4. Fresh air setting (where optional fresh air module is fitted)**

AUTO (recommended) allows automatic control of fresh air quantity according to control system settings. MIN allows experienced operators to override automatic fresh air control and force the minimum fresh air quantity. MAX allows experienced operators to override automatic fresh air control and force the maximum fresh air quantity.

**5. Occupied/Unoccupied override**

Normally set to AUTO, allowing the time clock to control the Occupied and Unoccupied periods of the Variheat. The left-hand button sets the Variheat into Occupied mode. The right-hand button sets the Variheat into Unoccupied mode. If remote control of Occupied/Unoccupied is to be used, this control should be set to Unoccupied. (See page 16.)

**6. User settings**

Allows the user to change the settings of the Variheat (user pin code required to access).

**Service engineer settings**

These settings are for Dantherm Group service engineers and are password protected.

Functions on the second home screen can be modified if allowed by the User Security Mode settings. (See page 24.)

**POOL HALL  
HUMIDITY  
(%RH)**

**POOL HALL AIR  
TEMPERATURE  
(°C)**

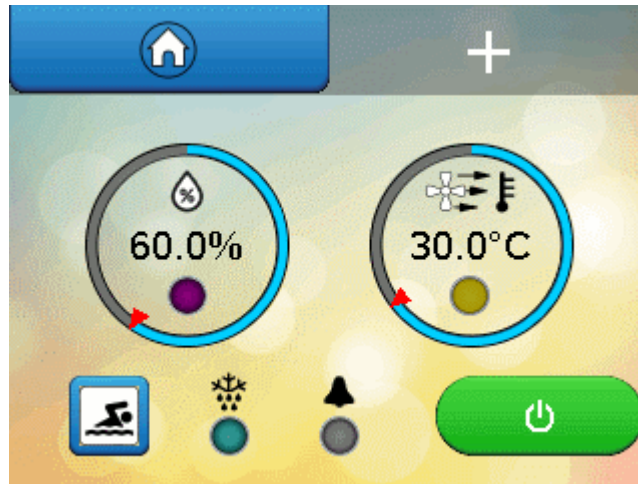

## HUMIDITY AND TEMPERATURE SETTINGS

It is essential to control the pool hall conditions 24 hours per day and, once commissioned, your Variheat should never be turned off if you are to avoid discomfort and/or expensive building damage due to humidity. It is a common mistake to believe that by turning the Variheat off will save running costs. This is not true. Turning the Variheat off turns off all the energy recovery it provides, and your swimming pool will cost you more to operate overall.

The energy usage and environment in a swimming pool are a delicate balance and your Variheat has been selected to operate at very specific conditions. The most important principle in a swimming pool is the difference between the air and water temperatures. For both economy and comfort, it is good practice to keep the air temperature in the pool hall 1-2°C above the pool water temperature while the cover is removed (Occupied Mode). A normal humidity target in a pool hall is 60%RH. These settings should correspond to the original design parameters for the project. Unless other conditions were specifically requested at the time the system was designed, the most common conditions used in indoor pools are:

- Water temperature 28°C-30°C
- Air temperature 29°C-30°C
- Relative Humidity 60%RH
- Changing the settings may result in high power consumption or less effective control of the environment. If you:
- Increase the water temperature – evaporation from the swimming pool water will increase, running costs will increase, and the likelihood of condensation will increase.

- Reduce the water temperature – evaporation from the swimming pool water will reduce, running costs will reduce.
- Increase the air temperature – evaporation from the swimming pool water will reduce, running costs usually reduce.
- Reduce the air temperature – evaporation from the swimming pool water will increase, running costs will increase, and the likelihood of discomfort and condensation will increase.
- Increase the humidity – running costs will reduce, but comfort will worsen, and the likelihood of condensation will increase.
- Reduce the humidity – running costs will increase, but may not improve comfort, nor reduce the likelihood of condensation.

If you do find it necessary to adjust settings, firstly ensure that the control system sensors are measuring accurately by using a calibrated thermometer and always maintain the air 1°C higher than water temperature. The settings for humidity (all models) and air temperature (AA+LPHW models only) can be changed by touching the centre of the corresponding parameter. A keypad appears. (See page 13.)

**Unless the Variheat has been specifically chosen for the purpose, do not operate with the air temperature below the water temperature when the cover is removed.**

The only exception is when a floating cover is in place on the pool (Unoccupied Mode).



**POOL OCCUPIED SYMBOL**



**POOL UNOCCUPIED SYMBOL**



## OCCUPIED AND UNOCCUPIED

Whenever a floating pool cover is in use, the cover suppresses evaporation and heat loss, so it is not necessary to maintain the air temperature higher than the pool water. Significant running cost reductions can be achieved by reducing the air temperature. Do not reduce the air temperature without a pool cover in place.

Normal operation, with the cover removed, is called Occupied Mode. Reduced air temperature operation, with the cover in place, is called Unoccupied Mode. It is expected that the pool will be covered during Unoccupied periods, to conserve energy and minimise evaporation. If Unoccupied Mode is used while the cover is removed, increased power consumption and loss of ideal conditions may result. The integral time clock on the control system allows fixed times to be set for when the cover will be in place. If you have an automatic pool cover, it may be possible to connect this to the Variheat as described in section 3.6, to automatically set Occupied and Unoccupied modes when the cover is moved.

The Variheat operates in either Occupied or Unoccupied Mode according to:

- User time period settings
- User override button
- Remote system connected to the interface terminals

In Occupied Mode, all functions operate according to User Settings.

In Unoccupied Mode, the following functions change:

- Pool hall air temperature setting reduced to the unoccupied temperature setting (sometimes called night set back). The pool hall will not be cooled

to this temperature, but if heating is required, it will only heat to this lower temperature setting (AA+LPHW models only).

- With the optional fresh air module, the fresh air volume is reduced to minimum, unless the user fresh air setting activates maximum fresh air.

### Going away for extended periods

Your Variheat system, once commissioned, should never be turned off completely. Even a cold pool will allow moisture to evaporate into the environment and if this is not dealt with expensive building damage may follow. If you go away for extended periods or wish to take the pool out of commission, use the following procedure:

Use a good swimming pool cover on the pool to minimise evaporation.

- Set the water temperature at 10°C
- Set the air temperature to 12-15°C
- Leave the humidity setting at 60-65%RH
- Leave the time clock setting in Unoccupied Mode

These settings will minimise energy usage whilst providing maximum protection for your building.



## 1.6 DATA ENTRY

Coloured buttons and parameters with a white background can be modified, except where locked by the User Security settings. Grey buttons and parameters with a grey background cannot be modified.

To change parameters with a white background, press the parameter. A keypad appears for number entry – an alphabet appears for text entry.

The keypad for entering numeric parameters is shown below. The parameter to be modified is shown at the top. The allowable range that the parameter can be changed between is shown underneath.

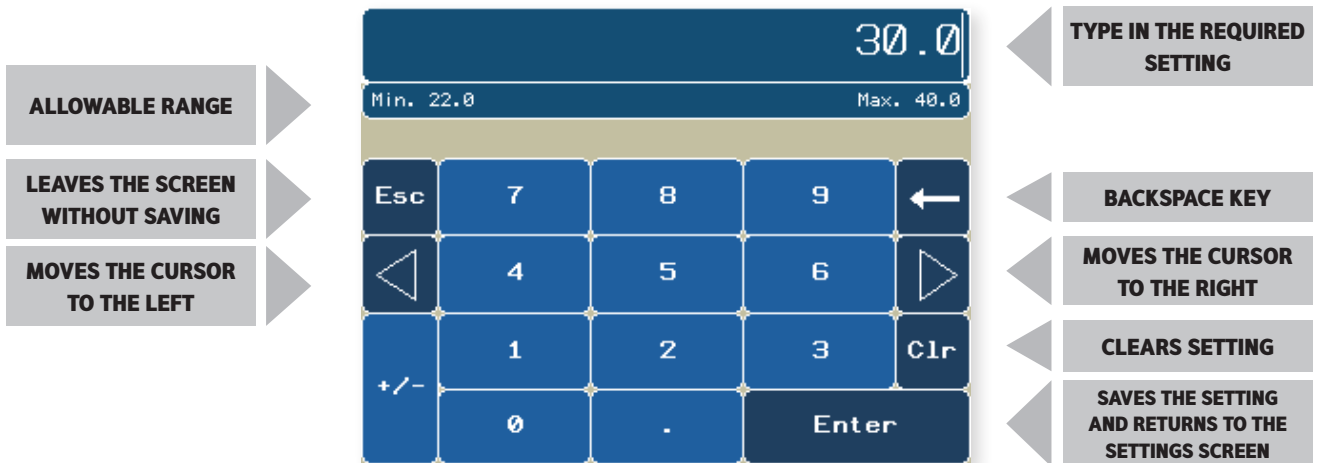

## SECURITY MODE

If Security Mode is enabled (see page 24) some functions may not be accessible from the home screens. Functions that are not accessible are shown with hashed lines. In the examples shown below all functions have restricted access apart from the fresh air settings and Occupied/Unoccupied override.

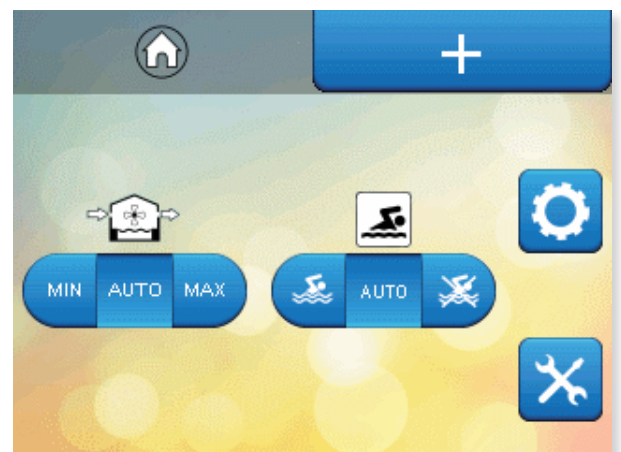
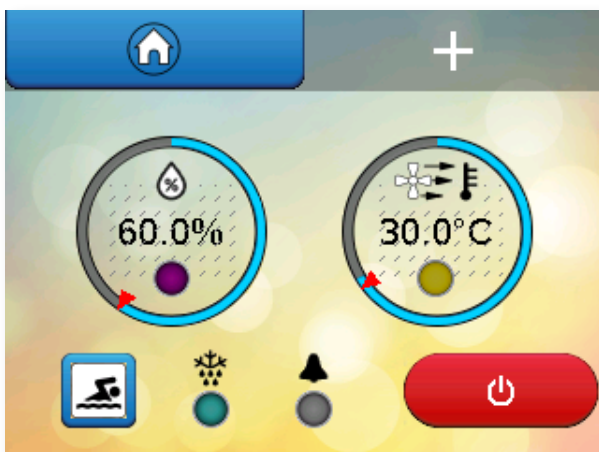

## 2.0 USER SETTINGS

The main User Settings screens are protected by a PIN code. User Settings can be accessed by pressing the cog button on the second Home screen.



USER SETTINGS

### INSERT THE PIN AND PRESS THE ARROW

The default **PIN** for accessing the User Settings is **6016**.

The Dantherm Group recommend this is changed.

Security options and record of PIN. (See page 24.)

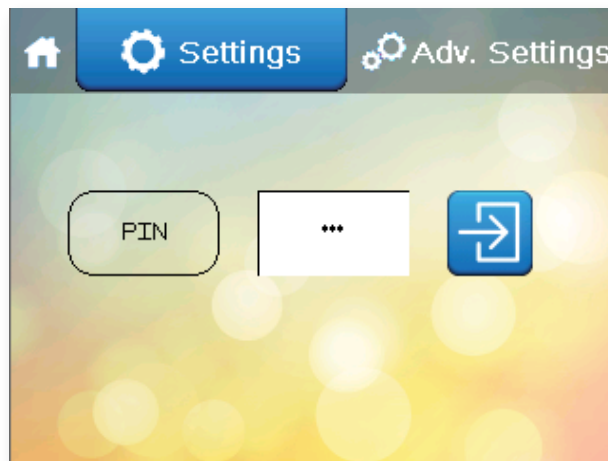

### THE SETTINGS SCREEN APPEARS

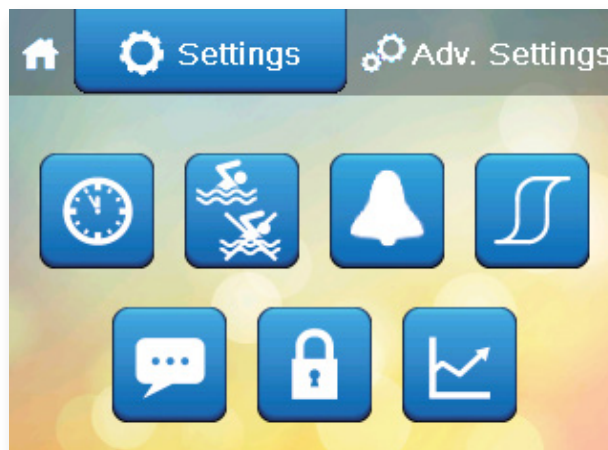

### Settings



Controller Clock



Occupied/Unoccupied periods



Alarms



Set Points and Switches



Language



User Security



Data Monitoring



## CONTROLLER CLOCK

Press this button on the Settings menu.



**Arrow icon**  
Return to  
User Settings



**Home icon**  
Return to  
Home screen



To change the date or time, press the white box with the number to be changed. Press Set Clock when the date and time are correct.

Press the Arrow to return to the User Settings screen or if nothing else needs to be changed, press Home to return to the Home screen.

Once the time and date have been set this should not need to be done again as long as the Variheat is On or in Standby. The clock has a battery reserve fitted which, when charged, has an operating time of three days so that isolating the Variheat unit for short periods will not reset the clock. It may be necessary to set the clock if the Variheat is isolated from power or if there is an interruption to the power supply which lasts longer than three days.

## DAYLIGHT SAVING TIME



**Arrow icon**  
Return to  
User Settings



**Home icon**  
Return to  
Home screen



 This button is red when daylight saving is disabled and green when daylight saving is enabled.

Press the button to manually toggle between enabled and disabled.

Default factory settings are UK daylight saving periods and will change automatically on the dates set in this screen. Where the daylight saving times and dates are different to those shown, they can be changed here.

Press the Arrow to return to the User Settings screen or if nothing else needs to be changed, press Home to return to the Home screen.



**TIME CLOCK**

Press this button on the Settings menu.



**Home icon**  
Return to Home screen

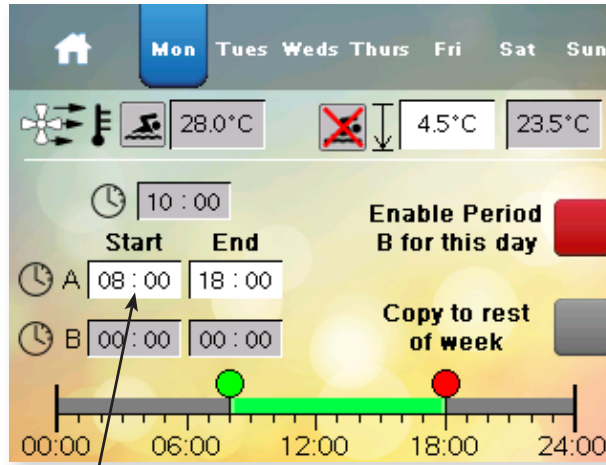

If a second occupied period is required enable this button. Times in the second period can be entered in B.

The times for the rest of the week can be copied by pressing this button.

Press the left side of the colon to change the hour setting.

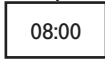

Press the right side of the colon to change the minute setting.

This screen can also be accessed from the first Home screen if the User Security settings are set to allow access.

When one of the time settings is touched, the keypad appears to allow the parameter to be changed. Any time with a white background can be changed.

There are two periods per day, A and B. Days can be set individually, or copied to the whole week. If A and B periods overlap, priority is given the Occupied period. If one Occupied period is required, period B can be disabled.

**AA+LPHW models only:**

The current Occupied air temperature and the Unoccupied air temperature settings are shown. The Unoccupied setting is set as the difference between the two, which can be changed. In the example above, the Occupied air temperature setting is 28.0°C and the Unoccupied air temperature setting is 4.5°C below that, 23.5°C. The minimum night set back temperature controlled by the Variheat is 22°C. This means that the greatest difference allowed is 6°C.

Press the Home button to return to the User Settings screen.



## ALARMS

Press this button on the Settings menu.



**Arrow icon**  
Return to  
User Settings



**Home icon**  
Return to  
Home screen

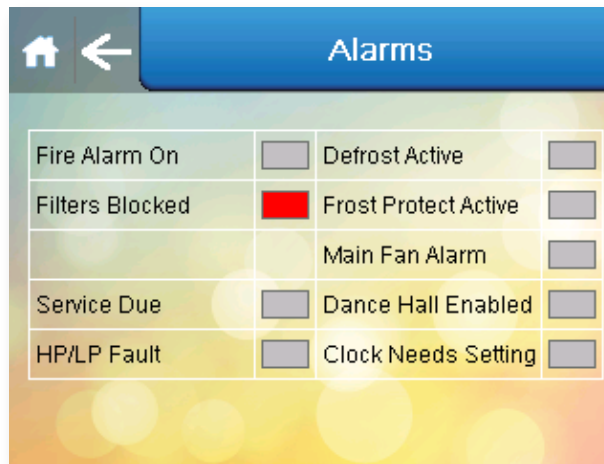

The Alarms screen displays warnings or faults with the Variheat, indicated by a red highlight. The example above indicates that there is a problem with the air filter that should be investigated.



### SET POINTS AND SWITCHES

Press this button on the Settings menu.



**Arrow icon**  
Return to  
User Settings



**Home icon**  
Return to  
Home screen

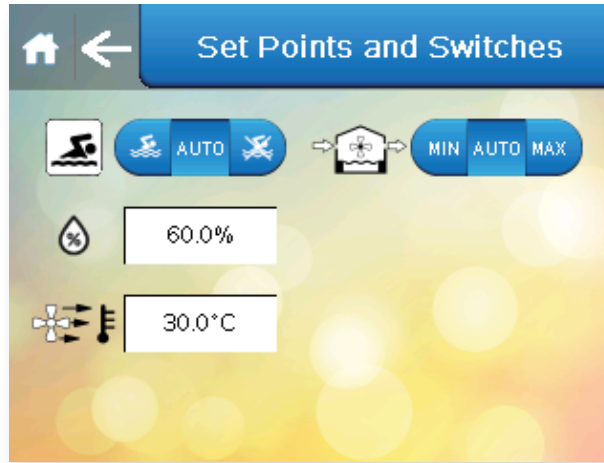

This screen duplicates settings on the Home screens. If functions on the Home screens are disabled by the User Security settings, they may be accessed here.

Press the Arrow to return to the User Settings screen or if nothing else needs to be changed press Home to return to the Home screen.

Note: the buttons on this screen may vary depending on the options fitted.



## LANGUAGE

Press this button on the Settings menu.



**Arrow icon**  
Return to  
User Settings



**Home icon**  
Return to  
Home screen



The available languages are shown on this screen and can be selected by pressing the button corresponding to the required language.



**USER SECURITY**

Press this button on the Settings menu.



**Arrow icon**  
Return to User Settings



**Home icon**  
Return to Home screen

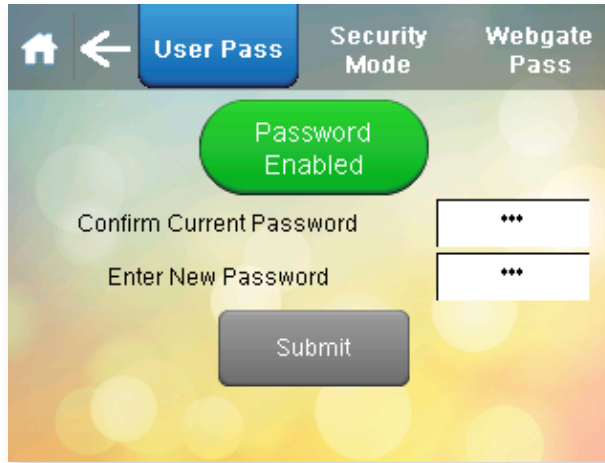

Toggles between Password Enabled and Password Disabled



If the User PIN needs to be changed, it can be changed here. The factory default User PIN is 6016. If the PIN is changed, write it in the box on the right and keep this manual in a safe place.

**USER PIN:**

The User PIN can be enabled or disabled. Pressing the Password Enabled/ Password Disabled button toggles between two. When disabled, the User Settings screen can be accessed without the User PIN.



**Arrow icon**  
Return to User Settings



**Home icon**  
Return to Home screen



Toggles between Security Mode Enabled and Security Mode Disabled



When Security Mode is enabled the buttons shown on the screen can be toggled between grey and orange. Settings in grey can be modified directly from the Home screens. Settings in orange are disabled on the Home screens and must be accessed through the User Settings.

When Security Mode is disabled, all home screen functions are set to grey and can be modified on the Home screens.

Press the Arrow to return to the User Settings screen or if nothing else needs to be changed, press Home to return to the Home screen.



## CHANGE WEBGATE PASS

Press the button on the right.



**Arrow icon**  
Return to  
User Settings



**Home icon**  
Return to  
Home screen

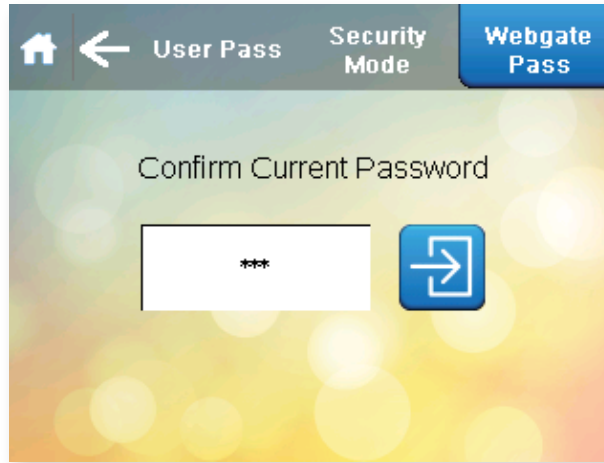

Press to confirm  
current password and  
proceed to the change  
password screen

The factory default Webgate password is DefaultPass.

For security reasons the Dantherm Group recommend that this password is changed.

If the password is changed, write it in the box below and keep this manual in a safe place.

**WEBGATE PASSWORD:**

If the password is forgotten, it can only be reset during a visit by a service engineer.

Press the Arrow to return to the User Security screen or if nothing else needs to be changed press Home to return to the Home screen.



**Arrow icon**  
Return to  
User Settings



**Home icon**  
Return to  
Home screen

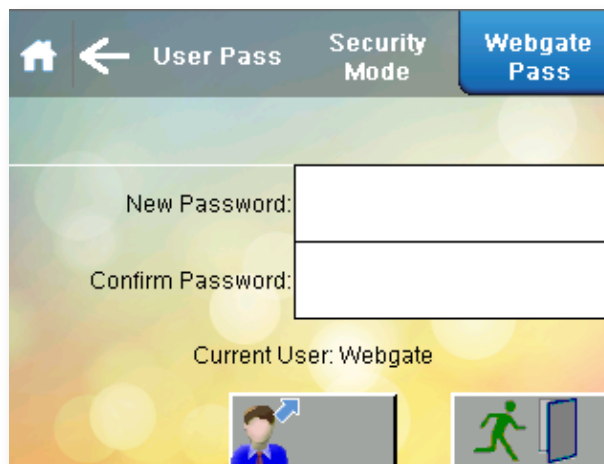

Button performs same  
function as Home button



**DATA MONITORING**

Press this button on the Settings menu.



**Arrow icon**  
Return to  
User Settings



**Home icon**  
Return to  
Home screen

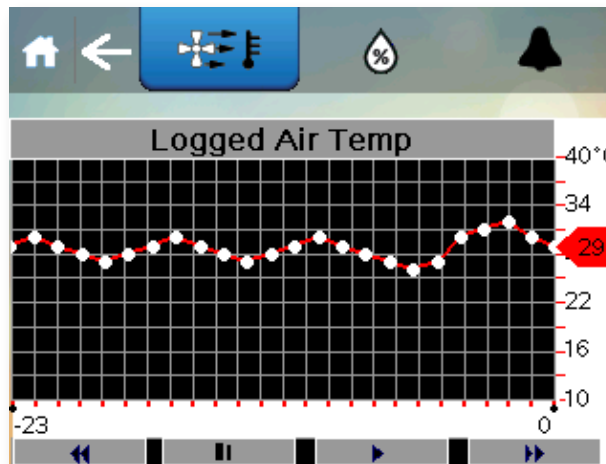

Pressing the buttons brings up a graph of the selected parameter. Choose from Air temperature, Humidity, Water temperature and Alarms. The display is marked up in hours and shows the past 72 hours of activity.



**Arrow icon**  
Return to  
User Settings



**Home icon**  
Return to  
Home screen

Date	Time	Message

Press the Arrow to return to the User Settings screen or press Home to return to the Home screen.

## 2.1 ADVANCED SETTINGS

Press this button on the Settings menu.

**WARNING**  
**ACCESSING THE ADVANCED SETTINGS BY PUTTING IN THE ONE TIME PASSWORD TAKES YOU INTO PARAMETERS THAT MAY FUNDAMENTALLY CHANGE THE WAY THE VARIHEAT BEHAVES. A SERVICE VISIT MAY BE NECESSARY IF THE PARAMETERS ARE CHANGED INCORRECTLY.**

The one-time PIN for accessing these screens is 1842. Once this PIN has been entered once, you will not be prompted for this password in the future.

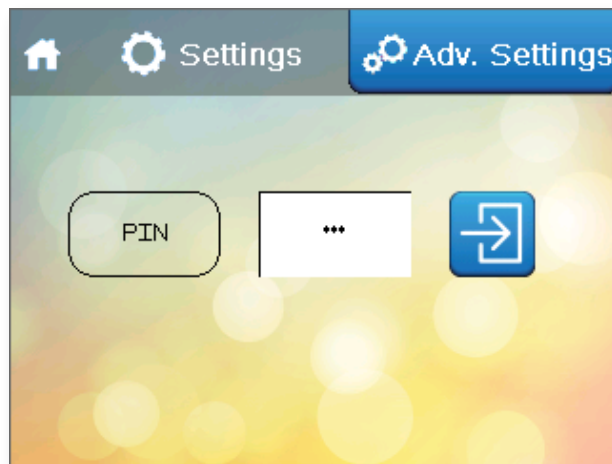

The Advanced Settings screen appears.

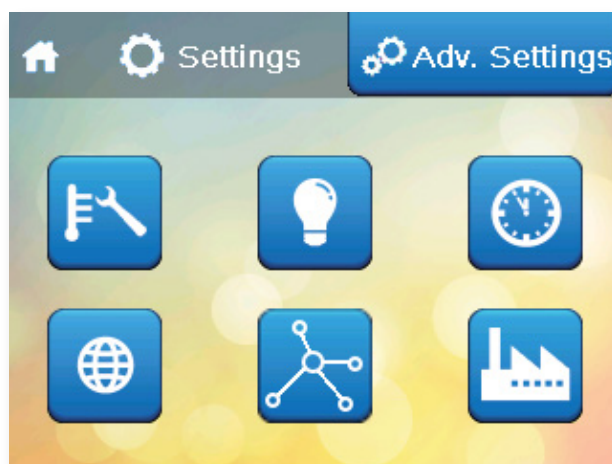

### Advanced Settings



Offsets



Screen Settings



Customer Timers



IP Address



BMS Settings



Reset to Factory  
settings



**OFFSETS**

Press this button on the Advanced Settings menu.



**Arrow icon**  
Return to  
User Settings



**Home icon**  
Return to  
Home screen

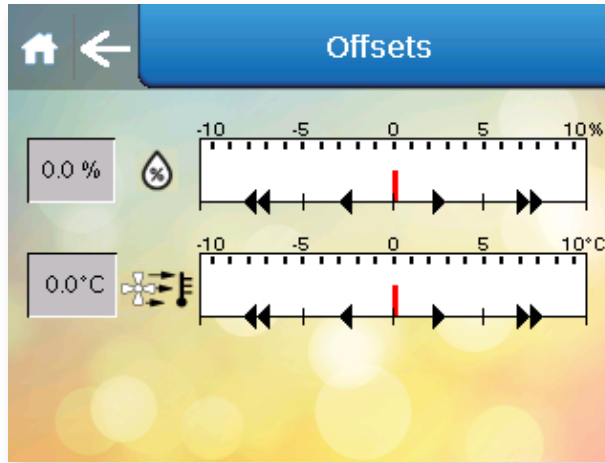

**Offsets**

The actual conditions in the pool may be slightly different to the conditions detected and shown on the display. If this is due to sensor calibration, a correction can be entered here to improve accuracy. For example, the Variheat displays an air temperature of 29.5°C, and a calibrated thermometer measures 30.0°C. In this instance an offset of +0.5°C can be applied to calibrate the sensor.

The single arrows change the offset in 0.1 increments.  
The double arrows change the offsets in 1.0 increments.

Press the Arrow to return to the Advanced Setting screen or if nothing else needs to be changed press Home to return to the Home screen.



## SCREEN SETTINGS

Press this button on the Advanced Settings menu.



**Arrow icon**  
Return to  
User Settings



**Home icon**  
Return to  
Home screen

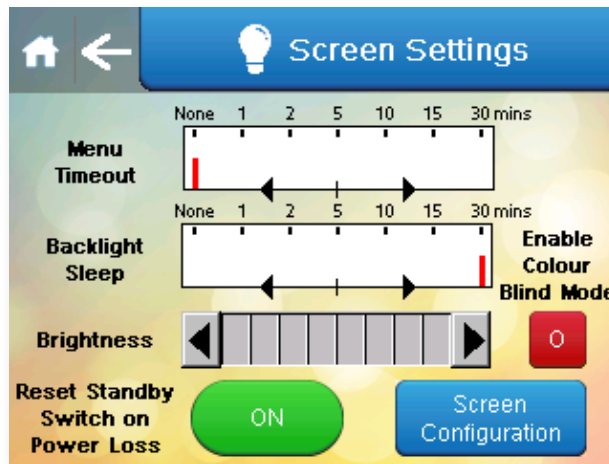

The screen settings can be changed here.

**Menu Timeout** – the length of time after which the display to automatically return to the Home screen after the last screen press.

**Backlight Sleep** – the length of time after which the display switches off after the last screen press. Touching the screen will restore the display.

**Brightness** – can be increased or decreased.

**Colour Blind Mode** – can be enabled to improve colour contrast. Press the Arrow to return to the Advanced Settings screen or if nothing else needs to be changed press Home to return to the Home screen.

The “Reset Standby Switch on Power Loss” button determines what happens when power is interrupted.

When set to ON the Variheat restarts in Standby mode when power is reconnected, and does not function until the On/Standby button is pressed.

When set to OFF, the Variheat tries to restart all functions automatically when power is reconnected. During a unplanned power cut, safety devices may activate to protect the Variheat system and may require resetting by the user.

**Screen Configuration settings button** – allows access to advanced screen configuration settings. The touchscreen can be recalibrated here if it does not register finger or stylus touches in the correct position. Other settings should be left as default unless changes are advised by the Dantherm Group.



### CUSTOMER TIMERS

Press this button on the Advanced Settings menu.



**Arrow icon**  
Return to  
User Settings



**Home icon**  
Return to  
Home screen

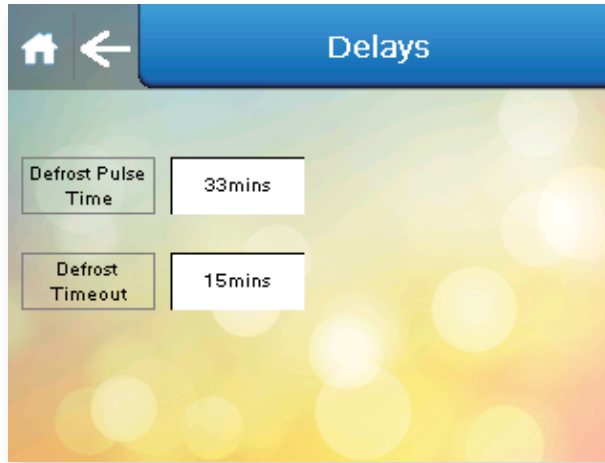

Defrost Pulse Time, Defrost Timeout - should be left as defaults settings unless advised to change by Dantherm or your Dantherm Group service engineer.



## FACTORY RESET

Press this button on the Advanced Settings menu.



**Arrow icon**  
Return to  
User Settings



**Home icon**  
Return to  
Home screen



If the settings have been changed in a way that makes the Variheat behave in an unusual way, the original commissioned settings can be restored by pressing the Reset to Commissioned Factory Defaults button on this screen. After this has been pressed a confirmation appears, pressing again completes the reset.

Press the Arrow to return to the Advanced Setting screen or if nothing else needs to be changed press Home to return to the Home screen.



## NETWORK SETTINGS

Press this button on the Advanced Settings menu.



**Arrow icon**  
Return to  
User Settings



**Home icon**  
Return to  
Home screen

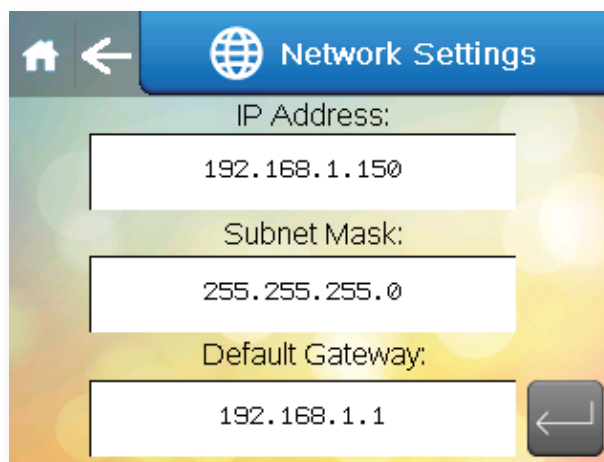

Insert the correct information, data shown here is an example.

This screen contains settings related to remote access by an Android/iOS device or ActiveX browser. (See Remote Access to the Variheat Touchscreen on page 34.) When accessing this screen on remote access, the IP address shown will be that of the access device, and it is not possible to view/change the Variheat IP address. The Variheat IP address can only be changed from the touchscreen.

Press the Arrow to return to the Advanced Setting screen or if nothing else needs to be changed press Home to return to the Home screen.



**BMS SETTINGS**

Press this button on the Advanced Settings menu.



**Arrow icon**  
Return to User Settings



**Home icon**  
Return to Home screen

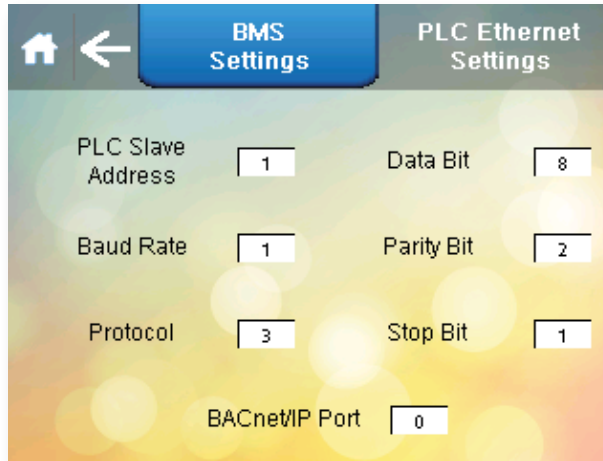

This screen contains settings related to BMS connectivity when using Modbus/RTU and BACnet MS/TP through the spare RS485 port. The factory default settings are shown. If connecting using BACnet/IP, see the PLC Ethernet Settings screen on page 30.

Slave Address. Can be set from 0 to 255.

Baud Rate. Can be set from 0 to 5, corresponding to:

0	9600
1	19200
2	38400
3	57600
4	76800
5	115200

Protocol Used. Can be set from 2 to 4, corresponding to:

2	uNET
3	Modbus/RTU
4	BACnet MS/TP

Data Bit. Always set to 8. Included for information only, to configure own software if needed.

Parity Bit. Can be set from 0 to 2, corresponding to:

0	Null
1	Odd
2	Even

Stop Bit. Can be set from 1 to 2.

BACnet/IP Port – can be set from 0 to 65535. 0 corresponds to the default port 47808. 65535 corresponds to BACnet stack running only on PLC side.

**After changing any of the above settings, restart the PLC/Variheat, by cycling the power supply, to save and apply the new settings.**

For Modbus Variable list and BACnet Object list please consult the Dantherm Group.



## PLC ETHERNET SETTINGS

Press the button on the right.



**Arrow icon**  
Return to  
User Settings



**Home icon**  
Return to  
Home screen

BMS Settings		PLC Ethernet Settings	
<b>Enable DHCP</b> <input type="checkbox"/>			
IP Address:		Primary DNS:	
192	168	8	8
0	100	8	8
Subnet Mask:		Secondary DNS:	
255	255	8	8
255	0	4	4
Default Gateway:		HTTP Port:	0
192	168	TCP/IP Port:	502
0	1		

This screen contains settings related to BMS connectivity using BACnet/IP through the Ethernet port on the PLC. The factory default settings are shown. If connecting using Modbus/RTU or BACnet MS/TP, see the BMS Settings screen on page 31.

Enable DHCP. This button toggles between DHCP enabled or disabled.

IP Address, Subnet Mask, Default Gateway, Primary and Secondary DNS – all fields can be set from 0 to 255.

HTTP Port. Can be set from 0 to 65535. 0 corresponds to default port 80.

TCP/IP Port Can be set from 0 to 65535. Default is 502.

**After changing any of the above settings, restart the PLC/Variheat, by cycling the power supply on/off, to save and apply the new settings.**

For Modbus Variable list and BACnet Object list please consult the Dantherm Group.

## 2.2 REMOTE ACCESS TO THE VARIHEAT TOUCHSCREEN



The Variheat can be controlled remotely either through a mobile device using a third-party Android/iOS app, or using a computer with a web browser that can run Active X.

The Variheat touchscreen must be connected to a LAN (local area network), accessible to the device or computer to be used.

### Local area network connection

The RJ45 Ethernet port on the back of the touchscreen should be used (see page 48).

The default network IP address for the Variheat is 192.168.1.150, but may be changed as required (see section 2.1 Network setting).

If the Variheat is only to be accessed by devices connected to the same network, no further network setup is necessary. If the Variheat is to be accessed from devices NOT connected to the same network, it is necessary to set port forwarding to the network IP address of the Variheat.

### Ports to be forwarded

80  
6000  
6002

If the Variheat is to be accessed from devices NOT connected to the same network, a static public IP address for the network is recommended. If your ISP (internet service provider) is not able to provide a static IP address, third party solutions are available to provide a static IP address, which may involve a cost.

Once set up, the Variheat may be accessed from an ActiveX enabled browser such as Internet Explorer, or a mobile device using the Vijeo Design'Air app

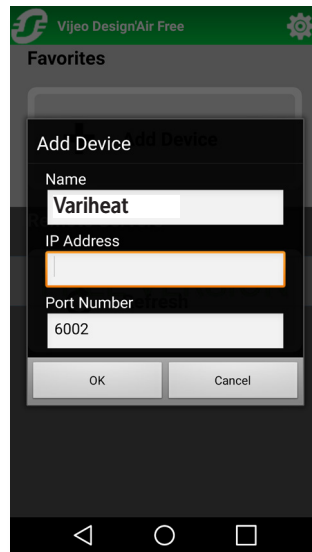
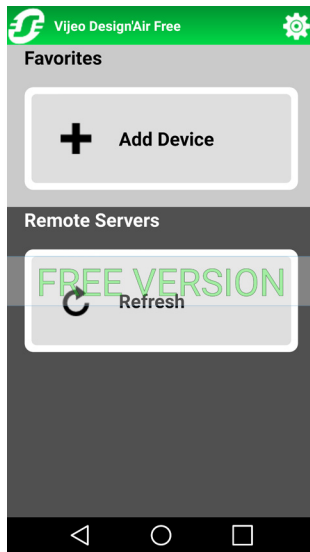

### Using an Android/iOS mobile device

The Variheat touchscreen can be controlled by a mobile device. To access the Variheat by a mobile device, the Vijeo Design'Air app must be installed on the device. A free version is available with restricted usage time. A paid version is available with unlimited access. The setup procedure depends how the remote access is to be used.

### If the Variheat is ONLY to be accessed when the device is connected to the SAME network as the Variheat:

After installing the app, open it and select "Add Device". In the fields that appear enter a name (e.g. Variheat), the network IP address of the Variheat (see section 2.1 Network setting) and leave the port number as the default setting. From now on the Variheat can be controlled from your mobile device by selecting it from "Favourites". Read the disclaimer carefully before accepting the terms and conditions of the app. The box needs to be ticked before the OK button can be pressed.

When the login window appears, login with the username "Webgate" and password. Both are case sensitive. The default password is "DefaultPass". For security reasons the Dantherm Group recommend this password is changed. (See section 2.1 User Security settings.)

### If the Variheat is to be accessed when the device could be anywhere:

First obtain the public IP address of the network the Variheat is connected to using another device that is connected to the same network. Search for "What is my IP" in a search engine and make a note. Ensure port forwarding has been set on the router as mentioned on page 34.

It is recommended to perform the app setup when the device is NOT connected to the same network as the Variheat (turn off wi-fi or leave the network area). After installing the app, open it and select "Add Device". In the fields that appear enter a name, e.g. "Variheat", the public IP address of the network and leave the port number as the default setting. From now on the Variheat can be controlled from your mobile device by selecting it from "Favourites". Read the disclaimer carefully before accepting the terms and conditions of the app. The box needs to be ticked before the OK button can be pressed.

When the login window appears, login with the username "Webgate" and password. Both are case sensitive. The default password is "DefaultPass". For security reasons the Dantherm Group recommend this password is changed. (See section 2.1 User Security settings.)

Depending on the router specification, these settings may also work whilst the device is connected to the same network as the Variheat. This can be tested with the device connected to the same network. If it does not work, it will be necessary to add a second device to the app, e.g. "Variheat home", using the network IP address (see above). Use the "Variheat" device when not connected to the same network and "Variheat home" device when connected to the same network.



**Using an ActiveX web browser on a networked computer**

To access the Variheat by a networked computer, a browser that can run ActiveX is required. This function has been designed and tested to work with Internet Explorer. Other browsers are not formally supported.

**For first time setup instructions, see right.**

Once the computer and browser have been setup, screen mirroring can be accessed as follows:

**If the Variheat is ONLY to be accessed when the computer is connected to the SAME network as the Variheat:**

In your browser address bar, enter the Variheat network IP address (default address 192.168.1.150) and press Enter or click Go.

**If the Variheat is to be accessed when the device could be anywhere:**

First obtain the public IP address of the network the Variheat is connected to using a computer that is connected to the same network. Search for "What is my IP" in a search engine and make a note. Ensure port forwarding has been set on the router as mentioned on page 34.

It is recommended to test this when the computer is NOT connected to the same network as the Variheat (turn off wi-fi or leave the network area). In your browser address bar, enter the public IP address of the network and press Enter or click Go.

Depending on the router specification, the public IP address may also work whilst the device is connected to the same network as the Variheat. If it does not work, it will be necessary to use the Variheat network IP address when the computer is connected to the same network.

**Whichever method is used, when the Variheat Controller appears:**

- Click "Monitoring" in menu bar of the main window.
- Click "In Frame" or "New Window" from under Webgate in the left-hand menu.
- When the login window appears, login with the username "Webgate" and password. Both are case sensitive. The default password is "DefaultPass". For security reasons the Dantherm Group recommend this password is changed. (See 2.1 User Security settings.)
- Read the warning message carefully and click "Continue to Main Screen." The Variheat can be controlled with a mouse as if using the integral touchscreen. Numbers and text can be entered with a keyboard.

Note that some settings can not be changed through remote access, e.g. Network Settings and Webgate Password.

**ActiveX browser first time set up procedure**

**Follow the user access instructions on the left, with the following additional steps.**

- When prompted, install the Vijeo-Webgate Control. This is stored on the Variheat controller, so internet access is not necessary. When prompted, allow Windows to install.
- When prompted, the Variheat IP address must be added to the browser Trusted Sites list. This is accessible on the Internet Explorer menu – **Tools > Internet Options > Security > Trusted Sites > Sites > Add**. It may be necessary to uncheck the "Require server verification" box to complete this action. This may be rechecked after the site has been added. If the IP address of the Variheat is changed, the new IP address must be added to the Trusted Sites list.
- When prompted, install the Active X runtime. This is stored on the Variheat controller, so internet access is not necessary. When prompted, allow Windows to install. If flagged by your anti-virus or firewall software, the runtime files should be allowed access.
- The browser should be restarted and standard user access instructions can then be followed.

## 3.0 INSTALLATION

### Installation summary

The Variheat is a fully packaged system, supplied as a single piece, ready for positioning and connection to services. The Variheat is designed to be installed in an internal plant room. The Variheat is suitable for operating in plantroom temperatures from 0°C to +40°C.

### Unloading and unpacking

On arrival, check the condition of the Variheat and that the controls, duct connections and pipe connections are in the positions ordered. Report any concerns to your supplier prior to installation.

### Items included with Variheat

- User/Installation manual
- Warranty registration card
- Touchscreen removal adapter

### Positioning

The Variheat must be kept upright at all times. The cabinet is designed to be supported from the bottom. If lifting with a crane, spreader bars should be used to protect the top of the cabinet from crushing.

### Siting

Ensure sufficient access to controls, service access panels and connections for users and service engineers. Due consideration should be given to Health and Safety when designing access for users and service engineers.

### Removing the fan module

In order to factory test the Variheat, it will be supplied complete, but if necessary, the fan module (and fresh air module, where fitted) may be separated to assist positioning where plantroom access is restricted. The following actions need to be completed:

- Disconnect flexible LPHW hoses
- Disconnect fan wiring, taking care to record all wire positions
- Unbolt fan module
- Unbolt fresh air module, if fitted, if required

Take appropriate care when moving the modules, which are very heavy, particularly the refrigeration module. Ensure suitable lifting equipment is available for the movements required.

Ensure all sections remain upright during positioning. To reconnect after positioning, reverse the actions listed above.

### Summary of connections and services

#### Ductwork

- Return air, from pool hall
- Supply air, to pool hall
- Exhaust air, to atmosphere (if fresh air module, or negative pressure module fitted)
- Fresh air, from atmosphere (if fresh air module fitted)

#### Plumbing

- LPHW system, flow and return
- Condensate drain

#### Electrical

- Power supply

#### Remote interfaces (if required)

- Terminals
- Network connection
- BMS connections

#### After installation

- Pre-commissioning checklist
- Initial start-up
- Commissioning
- Operator handover

#### Ongoing maintenance

The Variheat has been designed to operate continuously over a long service life. Preventative maintenance is essential to keep the system operating effectively and efficiently.

3.1 SITING, MACHINE LOCATION

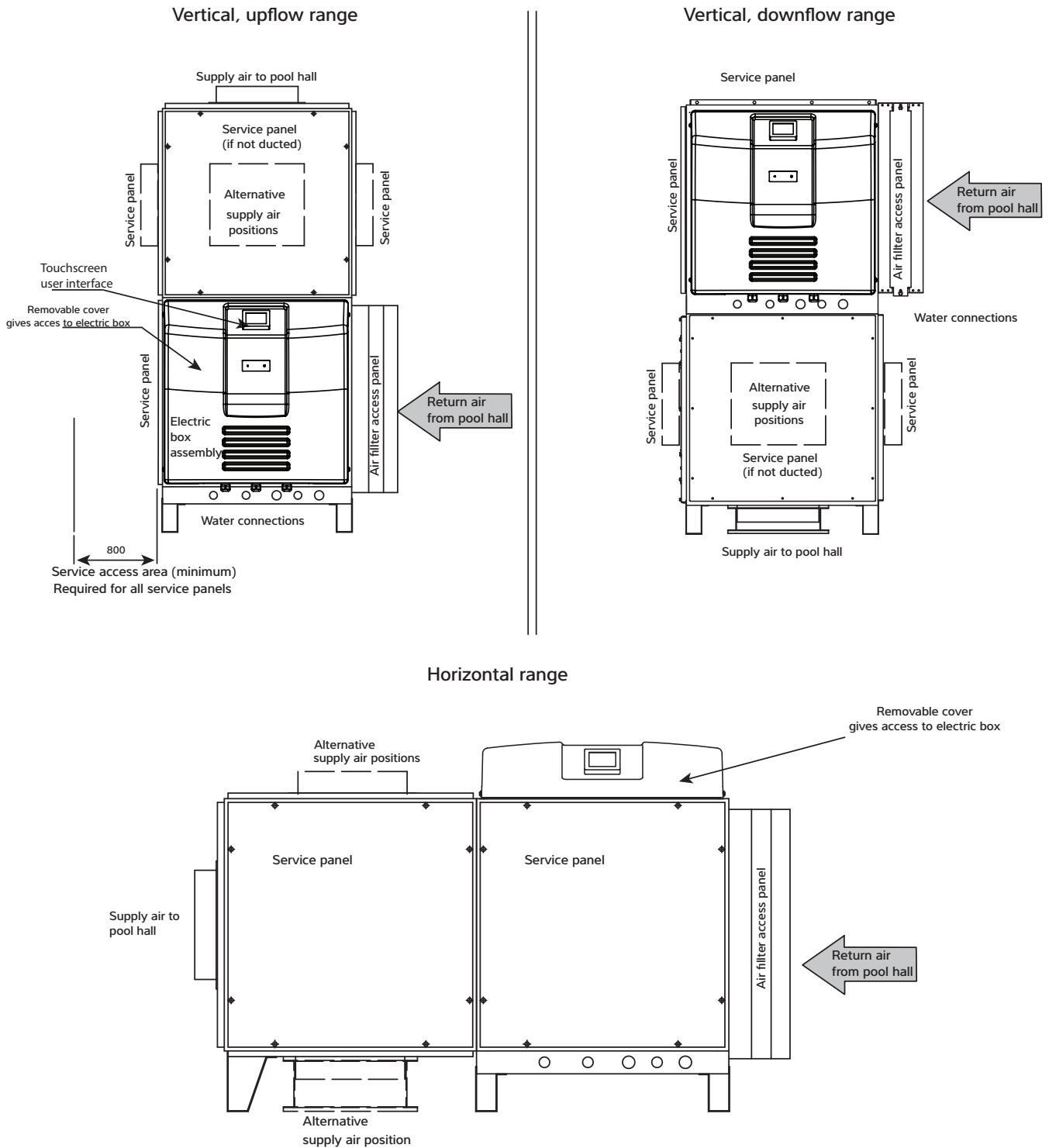

All ambient air ducting should be suitably insulated if plant room temperatures are significantly different from ambient, particularly where the plant room is at pool conditions. Spring return dampers are recommended for exhaust and fresh air ductwork in installations with sub zero ambient temperatures, in case of power failure.

**Important**

AA600 and 900 models are fitted with constant flow fans and self-regulate to deliver the optimum airflow, compensating for pressure differentials in the system. See data sheet for pressures available.

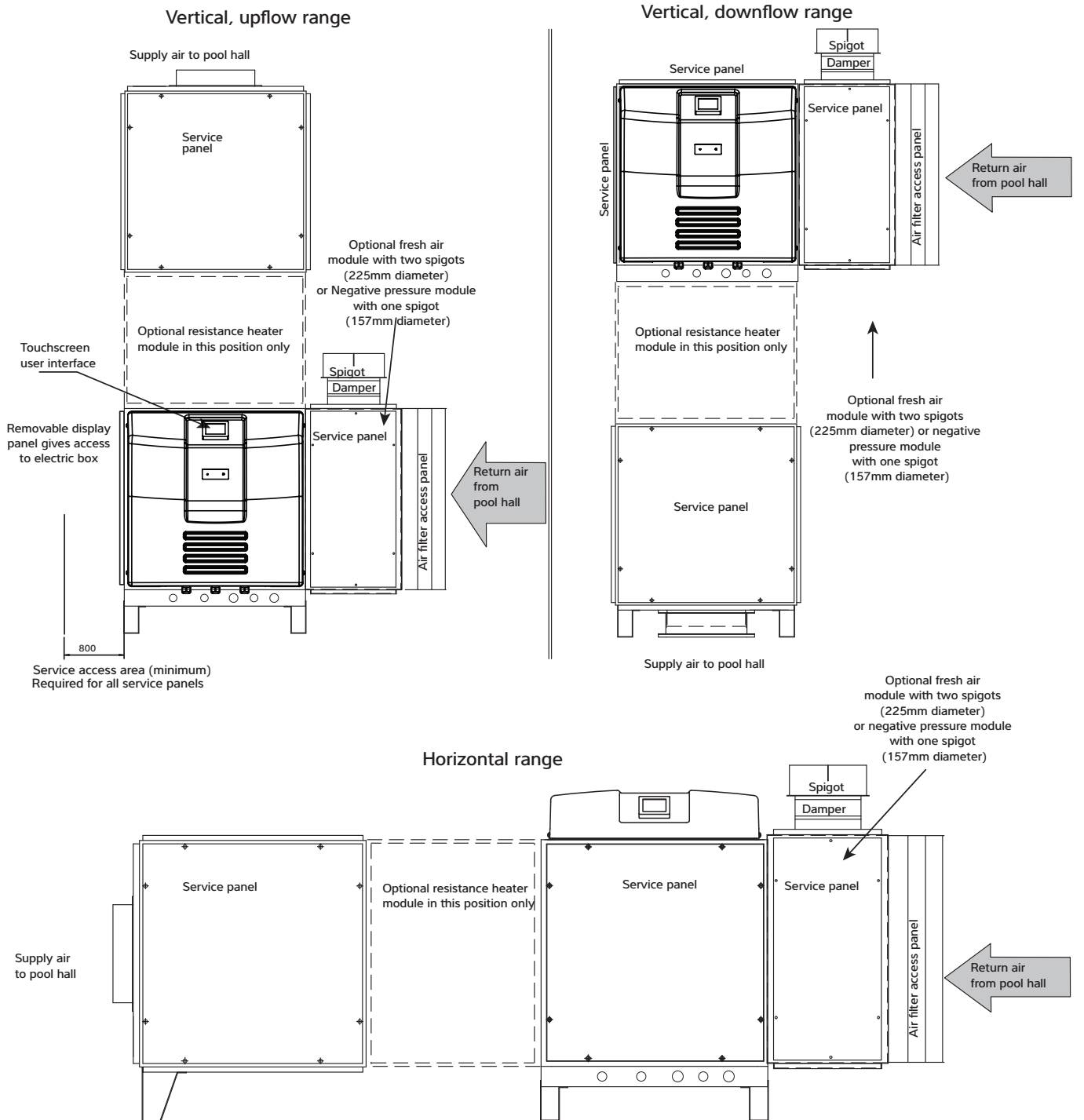

All ambient air ducting should be suitably insulated if plant room temperatures are significantly different from ambient, particularly where the plant room is at pool conditions. Spring return dampers are recommended for exhaust and fresh air ductwork in installations with sub zero ambient temperatures, in case of power failure.

**Important**

AA600 and 900 models are fitted with constant flow fans and self-regulate to deliver the optimum airflow, compensating for pressure differentials in the system. See data sheet for pressures available.

3.2 FRESH AIR AND EXHAUST AIR

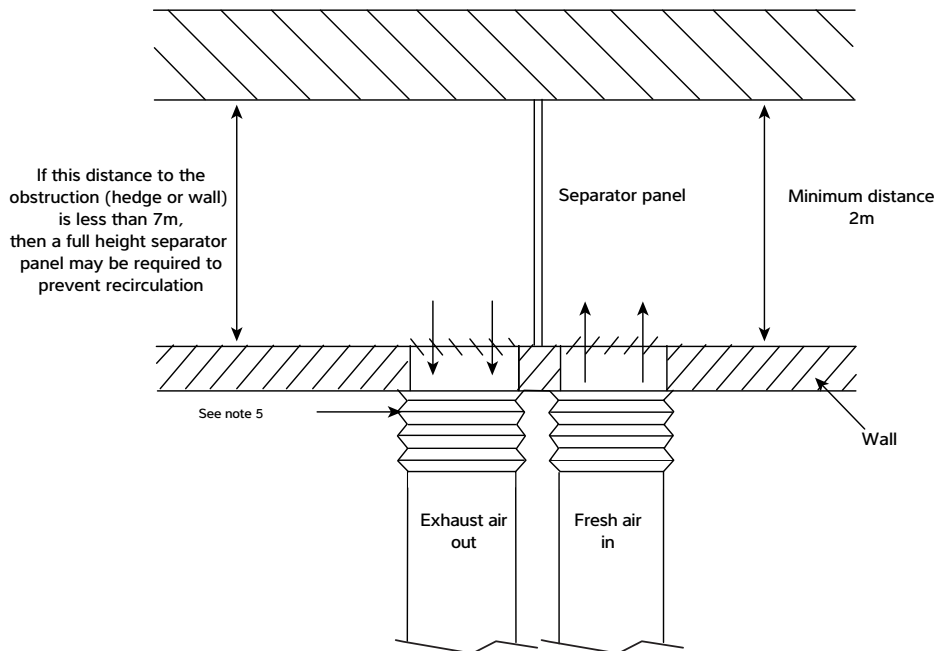
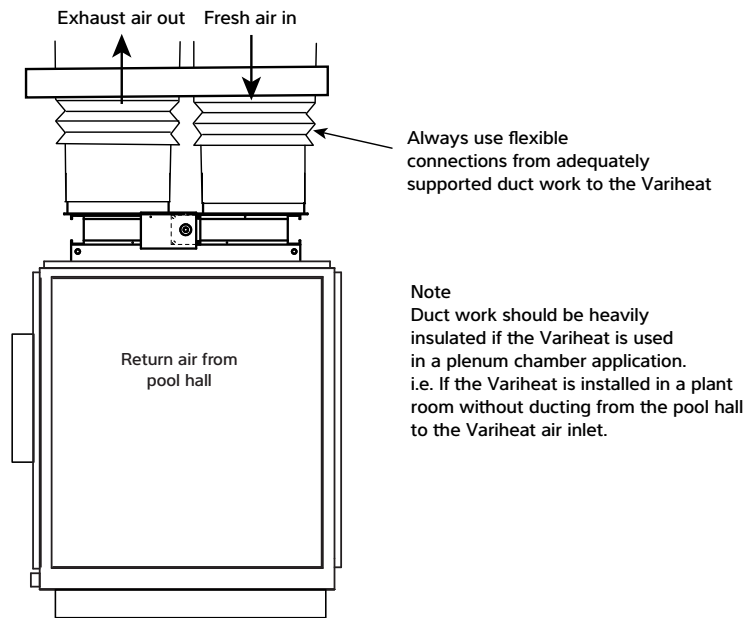

Notes

1. Ensure duct work pressure drop including all inlet/outlet grilles does not exceed resistance given in data sheet, section 5.0.
2. Every effort must be made to prevent re-circulation of exhaust air back into the fresh air inlet.
3. Ensure fresh air inlet does not become blocked by debris (leaves, grass cuttings, etc).
4. If unit is located in a plant room at pool hall air temperatures any ambient air ducting must be heavily insulated.
5. Ensure flexible couplings are used to seal the ambient suction and discharge spigots from each other to prevent cold air from entering the plant room.



### 3.3 PLUMBING INSTALLATION

The Variheat should be connected as shown in section 3.0.

#### Condensate drain

1. The condensate driptray in the Variheat collects the water removed by the dehumidification process. It is therefore necessary to ensure that the Variheat III is placed on a level plinth so that the condensate can run away and not overflow the edges of the driptray inside the machine.
2. All Variheat 3 models have a ¾" BSPM threaded condensate drain connection. The drain pipe should run away with adequate fall to waste ie ½" per foot min. and must incorporate a 'U' trap and tun dish.

#### LPHW plumbing

1. The LPHW connections for connecting the boiler water flow and return to the Variheat are:
2. ¾" BSPM on AA600/900  
1" BSPM on AA1200/1500
3. Suitable breakable couplings, isolation, and drain down valves should be installed in the boiler water flow and return pipes local to the Variheat.
4. LPHW circuits inside the Variheat should be bled for air pockets. (Bleed valves fitted internally).
5. A filter or magnetic trap needs to be in the boiler circuit to prevent the heat exchanger in the Variheat from blocking up.
6. Refer to the boiler manufacturers instructions before designing the pipework system.

#### Important general points

1. Do not route water pipes across service access panels or air inlet/outlets.
2. The water circuits to and from the Variheat should be capable of maintaining the specified water flow required.
3. All pipe work must be adequately supported with allowance for expansion and contraction.
4. It is recommended that when installing water systems the last connections to be made should be adjacent to the Variheat III to avoid undue stresses on the unit connections.
5. See warranty exclusions on page 68. for total list of water quality limits.

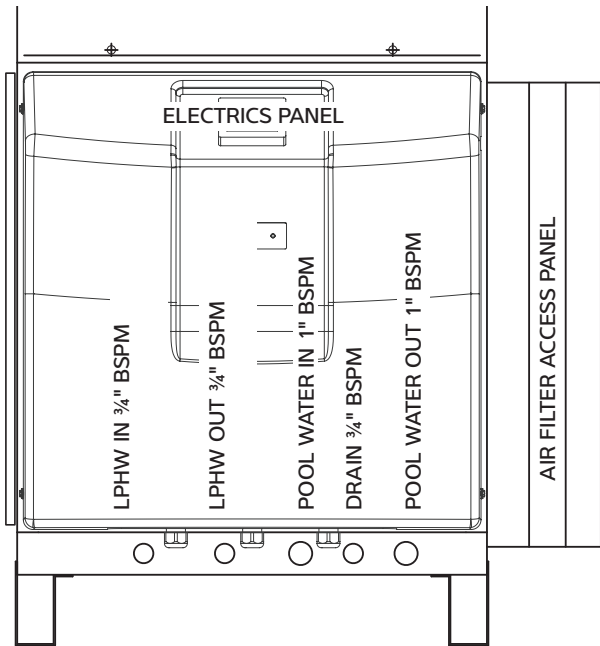

Variheat with standard pipe connections

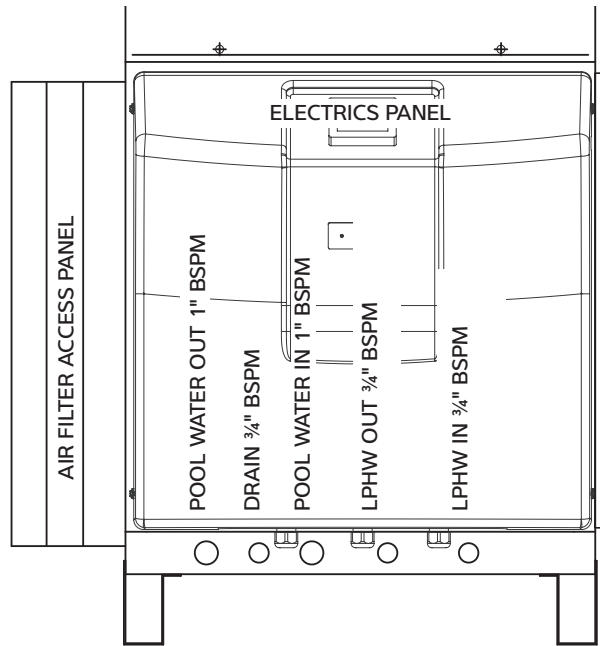

Variheat with RF pipe connections

**VH3 drain**

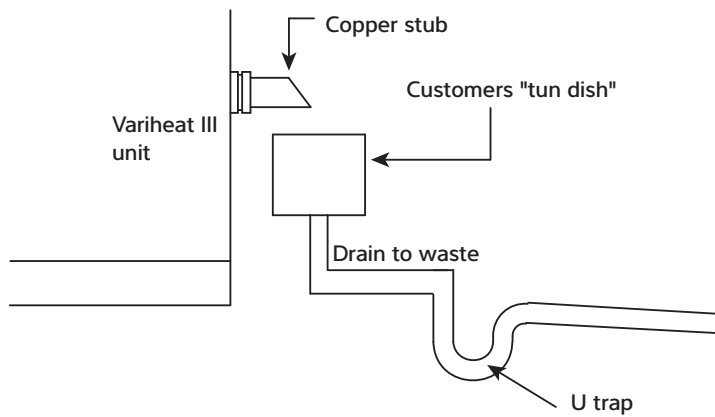

**LPHW Schematic**

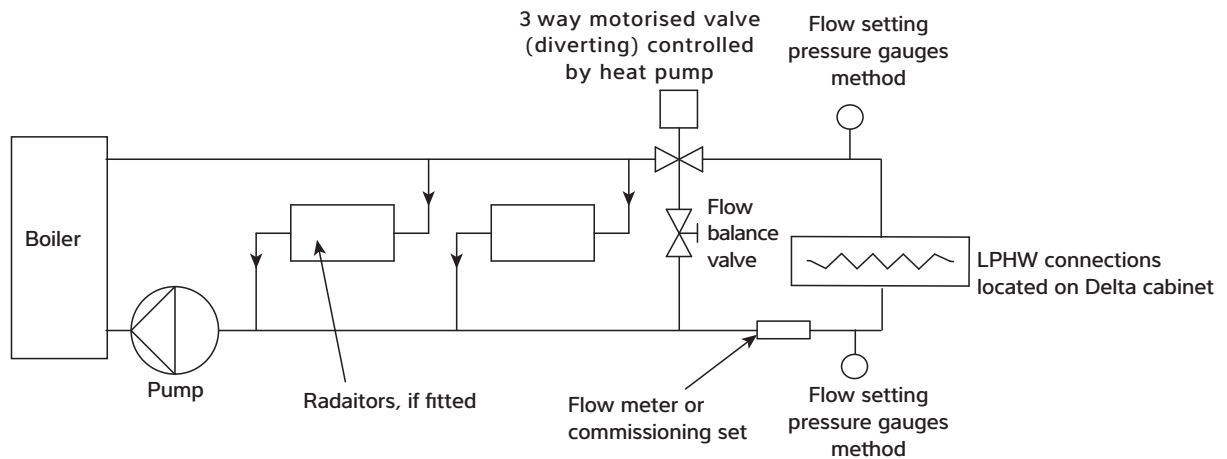

### 3.4 ELECTRICAL CONNECTIONS

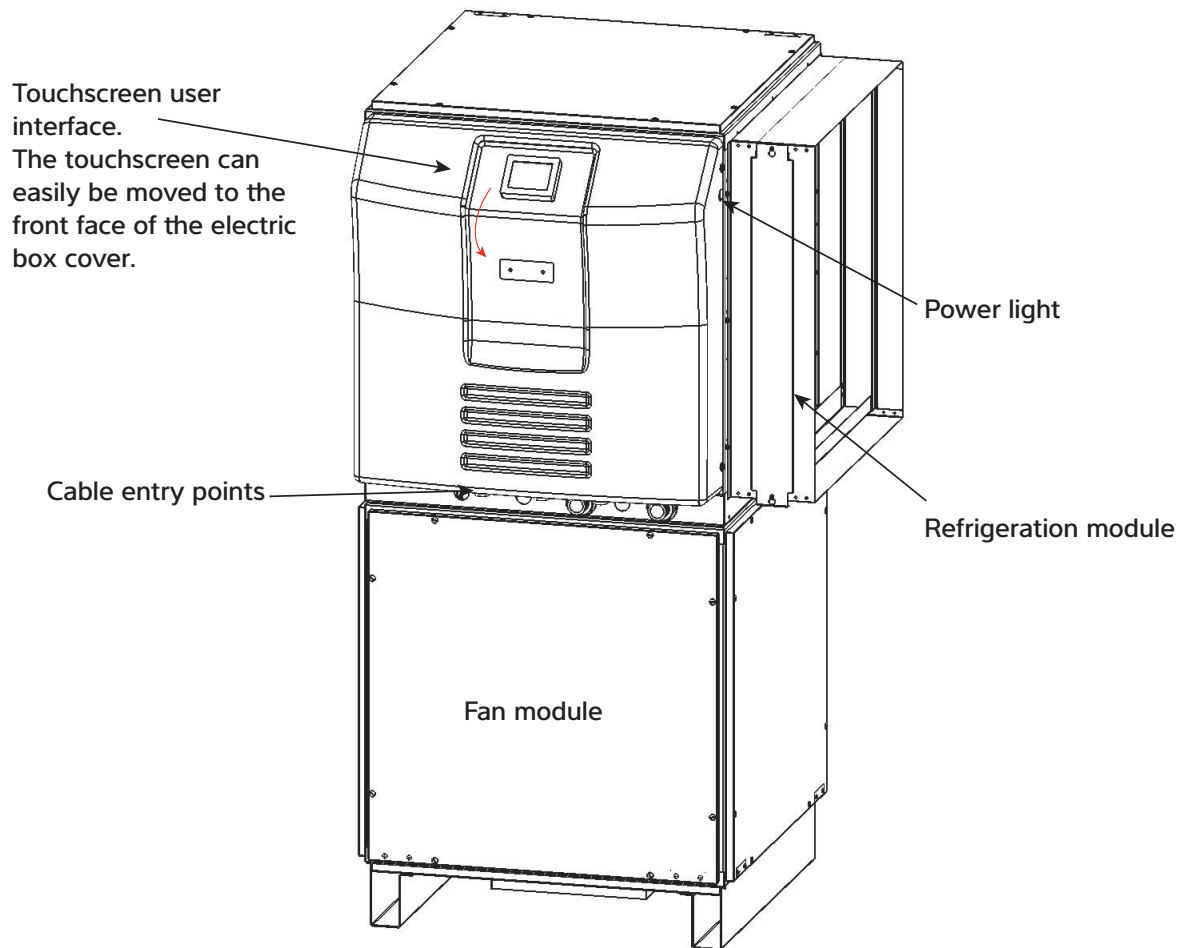

There are 3 cable glands in the electric box tray and two further knock-outs. Use the left hole for access to the power terminals. Use other available access points for the optional interface terminals.

All terminals are accessible by removing the electric box cover.

The touchscreen can be moved from the default location to the alternative position if this is more convenient for the user to access.

With the power isolated and the black cover removed, the screen rear can be removed by pressing the button on top. The screen can be unscrewed and moved to the alternative location or rotated by 180°. To rotate by 90°, remove the locating pin and ensure the screen is securely fixed to prevent rotation. Once the touchscreen is positioned, reattach the rear module.

### 3.5 ELECTRICAL INSTALLATION

#### Electrical safety

It is important to ensure that all aspects of the installation comply with the latest I.E.T. Regulations. It is also important to ensure that any remote devices which terminate within the pool hall are of the type and voltage as specified in the I.E.T. Regulations latest edition.

The machine should be installed in accordance with EMC2004/108/EC.

#### Protected supply

Whilst not mandatory, the Dantherm Group recommend that an R.C.C.B. is always fitted or that the supply is to local electricity authority recommendations, and that all ducting is bonded in accordance with these regulations.

The supply to the machine should incorporate fuses or motor rated circuit breakers (Type C) to specified rating. (See section 5.0 DATA SHEET on page 58.) H.R.C. fuses are recommended. An isolator must be fitted within clear view and not more than 2 metres away. The isolator must have a minimum 3mm air gap in the off position.

All units must be correctly earthed/grounded. An earth leakage trip is recommended to be fitted to all pool electrics.

#### Inconsistent electrical supply

The following limits of operation must not be exceeded if Calorex machines are to be guaranteed either in performance or warranty terms:

Voltage	Minimum	Maximum
Single phase machines	207V	253V
Three phase machines	360V	440V
Frequency	47.5Hz	52.5Hz

**Note:** The voltage must be measured at the heat pump mains terminals with all the fans/compressors running at the rated load condition.

#### Correct cable sizing

The cable supplying electricity to a machine with a given load must increase in cross sectional area (C.S.A) as the length increases in order that the voltage drop within the cable does not exceed recommended limits. **Cable sizing should be calculated by an approved electrician with due consideration to I.E.E and local codes of practice.**

**Note:** Three phase Variheat models 1200 and 1500, are fitted with phase protection and will not run if phases are connected incorrectly.

**Warning:** The red lamp adjacent to the control panel indicates that the Variheat is live. It is necessary to wait three minutes after the supply is disconnected before removing any panels or commencing servicing of the Variheat.

Power supply terminal block layout

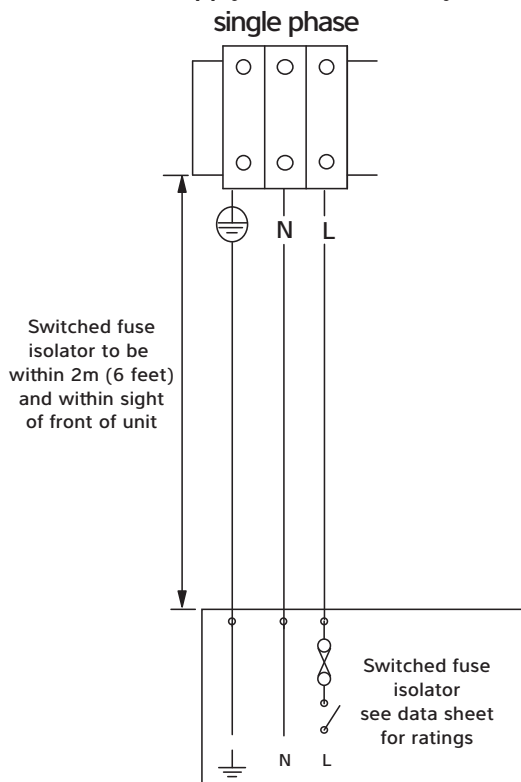

Power supply terminal block layout

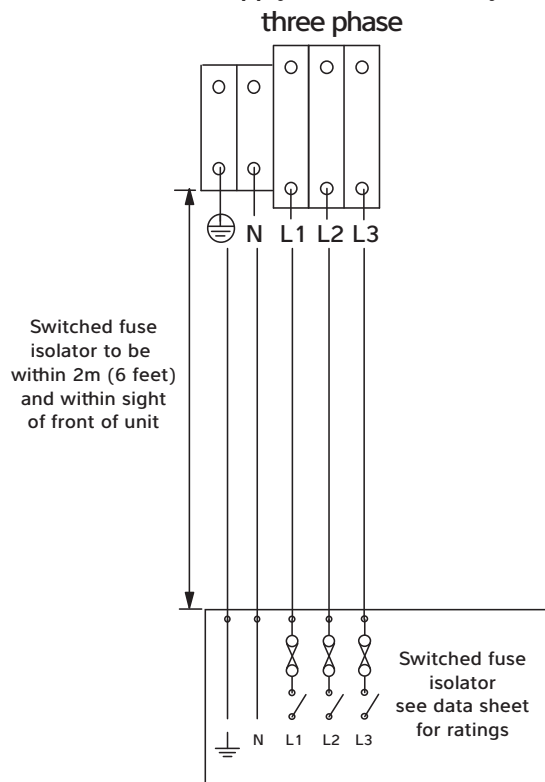

## Separate mains supply terminal blocks for resistance heater modules layout single and three phase

(no connection to terminals L2 and L3 on single phase units)

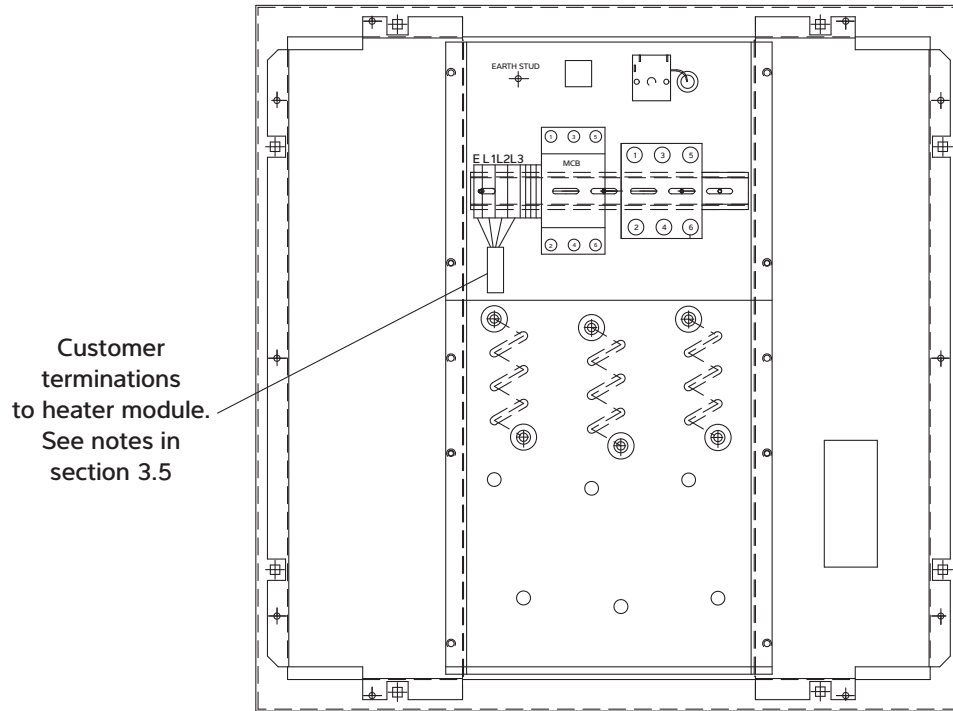

3.6 VOLT FREE TERMINALS AND REMOTE ACCESS

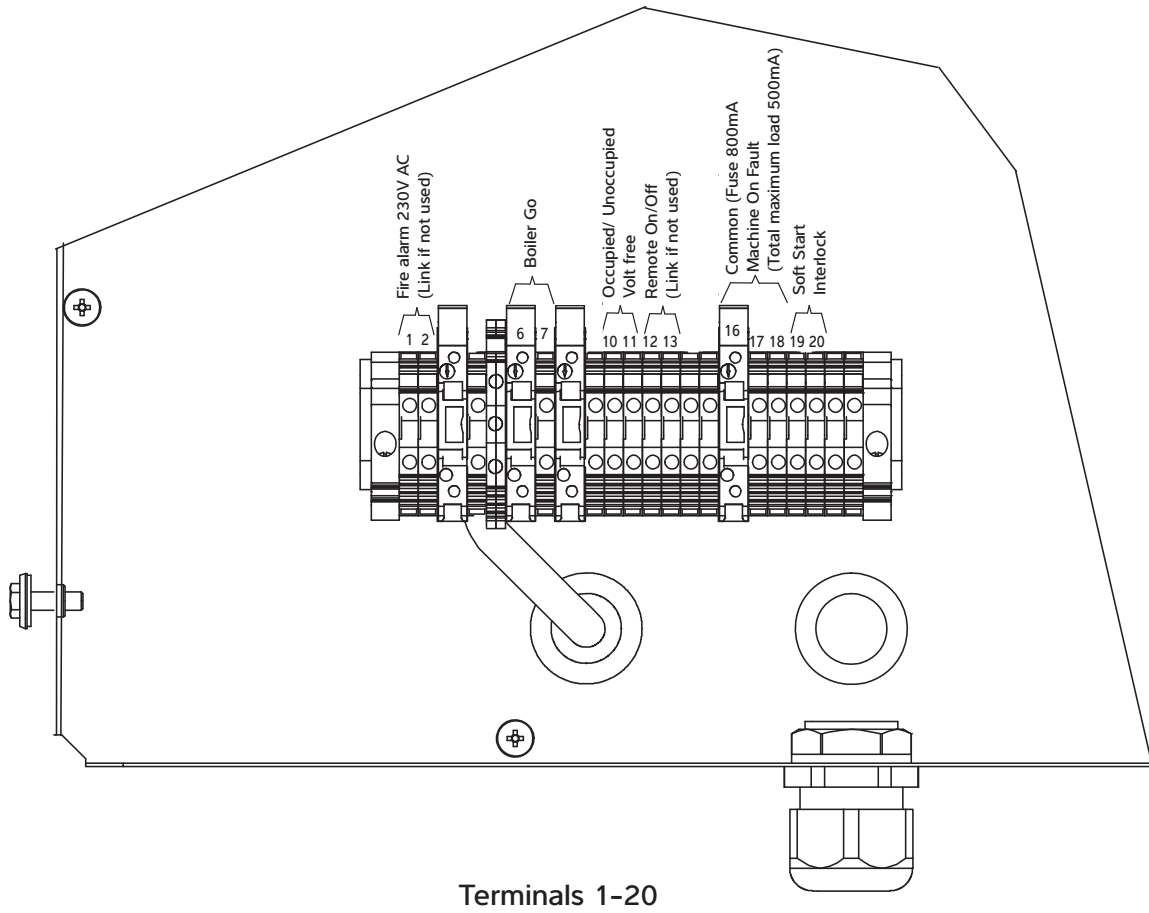

### **Fire Alarm interface – terminals 1/2**

For activating Standby mode in the event of a fire alarm. To enable the Variheat to run normally, the remote switch should be closed. To put the Variheat into Standby mode, the remote switch should be open. The remote switch should be volt free and suitable to switch 230V. An alarm will show on the control system when the fire alarm is activated.

If the fire alarm interface is required, the factory-fitted link wire should be removed.

If this facility is not required, the factory-fitted link wire should be left in place.

### **“Boiler Go” demand – terminals 6/7**

For remote indication that the Variheat LPHW heat exchangers are in operation, used to indicate that the Variheat requires LPHW to provide supplementary heating. This could be used to control a boiler, LPHW pump, LPHW control valve, or BMS – whichever are required to enable LPHW flow to the Variheat.

These are volt free contacts rated at 0.5A at 230V. Contacts close when LPHW is required.

If the LPHW supply to the Variheat is to be activated by the Variheat control system, these terminals should be used to enable the LPHW supply. The specifics of this connection depend on the design of the LPHW system design.

If the LPHW supply to the Variheat is not dependent on demand from the Variheat control system, these terminals do not need to be used.

### **“Time clock override” (remote Occupied/Unoccupied) – control terminals 10/11**

For remote control of the Variheat Occupied/Unoccupied mode.

To enable Occupied mode, the remote switch should be closed. To enable Unoccupied mode, the remote switch should be open. These terminals can be connected to a user switch, pool cover micro-switch, BMS, or whatever system determines the usage mode of the pool. The remote switch should be volt free and suitable to switch 24Vdc.

If remote control of Occupied/Unoccupied is to be used, the User interface should be set to Unoccupied. (See User Settings.)

If this facility is not required, these terminals do not need to be used.

### **“Remote On/Off” – terminals 12/13**

For remote control of On/Standby. To enable Variheat to run, the remote switch should be closed. To set the Variheat to Standby, the remote switch should be open. The remote switch should be volt free and suitable to switch 24Vdc.

Refer to Standby button function in the User instructions.

If remote On/Off control is required, the factory-fitted link wire should be removed.

If this facility is not required, the factory-fitted link wire should be left in place.

### **“Volt free” status signals – terminals 16/17/18**

For remote status indication. These are shared volt free contacts rated at a maximum combined 0.5A at 230V.

Terminal 16 – Common.

Terminal 17 – Variheat On. Contacts close when Variheat is On.

Terminal 18 – Fault. Contacts close when a fault is active.

If this facility is not required, these terminals do not need to be used.

### **“Remote Damper” control – terminals 63/64/65**

(See page 48.)

**“Remote Damper” control – terminals 63/64/65**

For control of a remote damper when Advanced Frost Protection is active.

These are powered terminals. Terminal 63 is Live (230V) when Advanced Frost Protection is active. Terminal 63 is fused at 160mA at 230V. Terminal 64 is Neutral. Terminal 65 is Earth.

If this facility is not required, these terminals do not need to be used.

**Advanced Frost Protection**

(Used when the remote damper is installed).

Advanced Frost Protection behaves in the same way as the standard Frost Protection with the addition of closing the remote damper. It also activates under the same conditions as standard, but will not deactivate when the temperature rises immediately. Instead, the machine will check the ambient temperature periodically (every six hours by default).

For each check, the remote dampers are opened for a short time (five minutes), fresh air is allowed to reach the probe and if the temperature has risen above the set point then Advanced Frost Protection is deactivated. If the temperature is still too cold, the machine remains in Advanced Frost Protection mode until the next check. An option to force a check can be found on the Set Points and Switches screen in the User Settings but only while Frost Protection is active.

**3.7 NETWORK CONNECTION**

**Local area network connection**

For screen mirroring to function (see Section 2.2 Remote access) the Variheat touchscreen must be connected to a LAN (local area network). The RJ45 Ethernet port on the back of the touchscreen should be used. The Ethernet controller supports the MDI/MDIX auto-crossover cable function, and may be used with either T568A or T568B wiring standards.

The default network IP address for the Variheat is 192.168.1.150, but may be changed as required (see section 2.1 Network setting).

If the Variheat is only to be accessed by devices connected to the same network, no further network setup is necessary. If the Variheat is to be accessed from devices NOT connected to the same network, it is necessary to set port forwarding to the network IP address of the Variheat.

**Ports to be forwarded**

- 80
- 6000
- 6002

If the Variheat is to be accessed from devices NOT connected to the same network, a static public IP address for the network is recommended. If your ISP (internet service provider) is not able to provide a static IP address, third party solutions are available to provide a static IP address, which may involve a cost.

Once set up, the Variheat may be accessed from an ActiveX enabled browser such as Internet Explorer, or a mobile device using the Vijeo Design’Air app. See section 2.2 Remote access for more details.

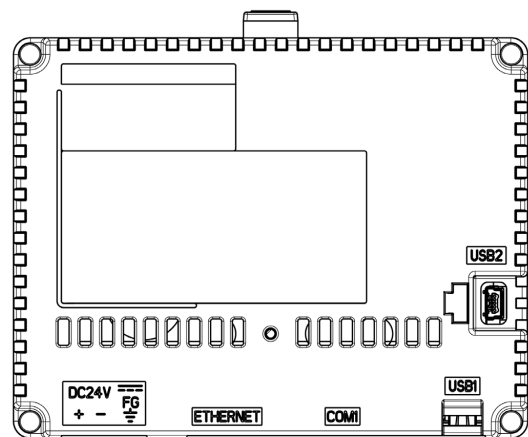

RJ45 Ethernet port



### 3.8 BMS CONNECTION (BUILDING MANAGEMENT SYSTEM)

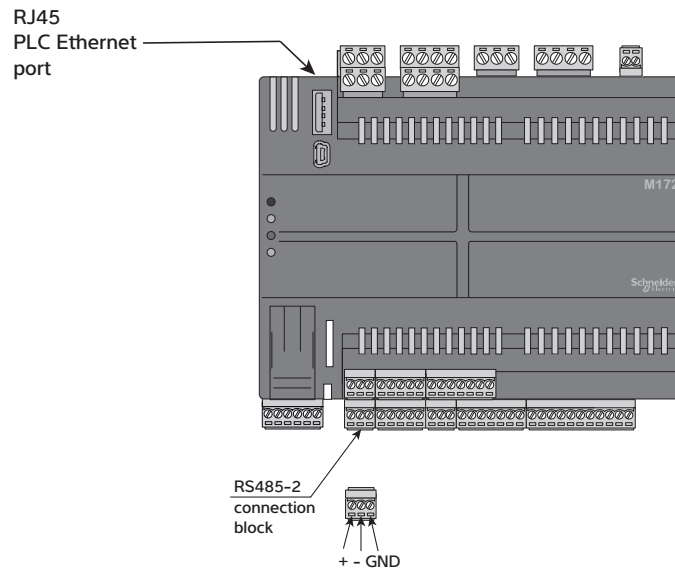

In addition to screen mirroring to the touchscreen (see section 2.1 Advanced Settings), the following options for connecting a BMS are included as standard.

- Modbus/RTU
- BACnet/IP
- BACnet MS/TP

Modbus is available via the RS485-2 interface on the PLC.

BACnet IP is available via the Ethernet port on the PLC.

BACnet MS/TP is available via the RS485-2 interface on the PLC.

(Only one BACnet connection may be used at any one time. BACnet and Modbus may not be used at the same time.)

For configuration settings, see the BMS Settings screen and PLC Ethernet Setting screen in Section 2.1 Advanced Settings.

For Modbus Variable list and BACnet Object list please consult the Dantherm Group.

### 3.9 OPTIONAL REMOTE SENSOR BOX

A remote sensor box is available allowing the air temperature and humidity sensors to be mounted in the pool hall. This may be beneficial if the sensors located within the Variheat cabinet are not able to get a representative measurement of the conditions.

When using 0.5mm<sup>2</sup> cable, the maximum total distance between the sensors and their terminals is 20 metres.

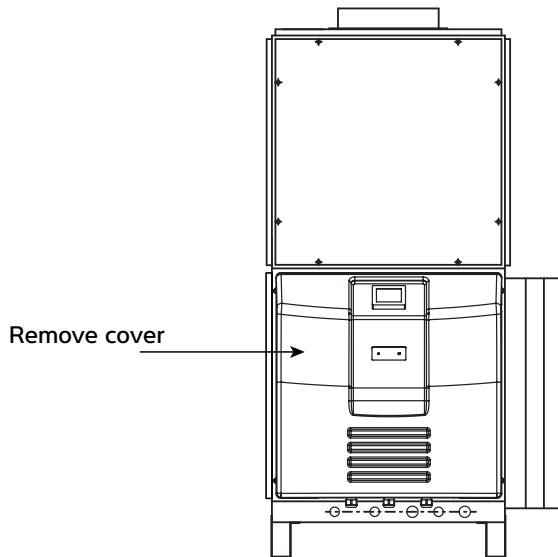

Terminal block layout

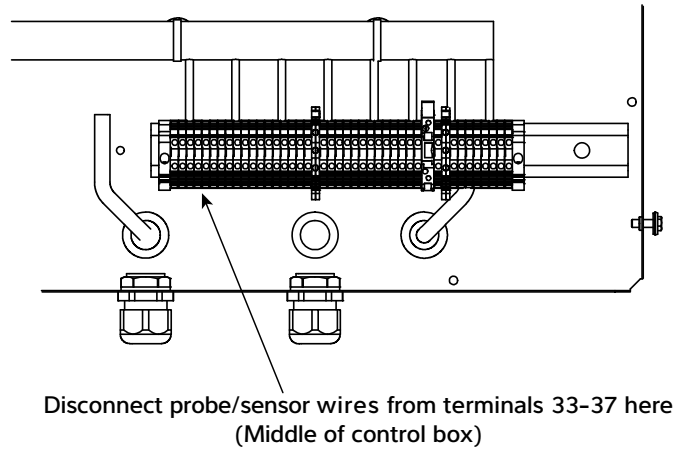

Remote sensor box

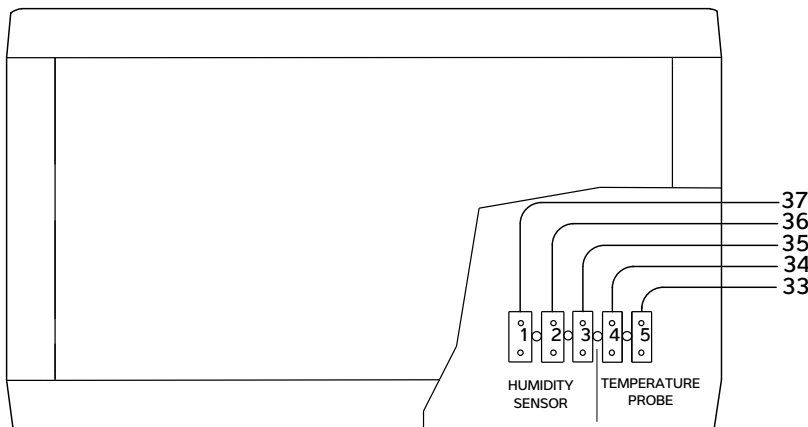

Connect terminals in sensor box to electric box terminal numbers

After the Remote Sensor Box has been connected it may be necessary to calibrate the sensor offsets. See Advanced Settings, OFFSETS for how to do this.

## 4.0 AFTER INSTALLATION

When the Variheat leaves the Dantherm Ltd. factory it is fully tested and is ready to operate when connected to the correct power supply, services and ductwork. The default settings allow the Variheat to be powered and started safely, provided the pre-commissioning checklist has been actioned.

### Pre-commissioning checklist

- In order for the Variheat to be properly commissioned after installation, the following actions are essential:
- The pool hall structure is complete and sealed according to the design specification.
- All ductwork is fully installed and finished, including all inlet and outlet grilles.
- LPHW connections are complete and the heat source is installed, fully commissioned and operational (AA+LPHW models only).
- All electrical connections are complete and all power and control systems are wired and fully commissioned.

### Initial start-up

After installation and completion of the services on the pre-commissioning checklist, the Variheat can be started:

- Connect power by turning on the local isolator.
- Confirm the red power light illuminates.
- The touchscreen should turn on and go through a start-up sequence after a short delay. If the touchscreen does not start, check:
  - Correct phase rotation
  - Control MCB inside the electric box is turned on
  - Touchscreen cable connections
- When the touchscreen displays the first home screen, the Variheat can be turned on via the touchscreen (see User Settings).

The Variheat should be started before commissioning to ensure the pool hall air has reached design temperature prior to commissioning. The default settings will normally allow the Variheat to stabilise the conditions ready for commissioning.

### Commissioning

For full commissioning procedure, please refer to separate commissioning document and report, which should be completed fully. Summary of commissioning procedure:

#### Pool hall and plant room

- ✓ Check – is the building finished in accordance with the original plans and specification, ready for commissioning? Check current temperatures and humidity, calibrate air/water temperature and humidity sensors.
- ✓ Check – is Variheat service and maintenance access adequate?

#### Ductwork and air flows

- ✓ Check – is all ductwork and any plenum chamber insulated? Special attention should be made to the insulation of any exhaust air and fresh air inlet ducting to prevent condensation problems.
- ✓ Check – are there any significant draughts in the pool hall (or plant room if used as a plenum) through poorly fitting doors, windows, pipe ducts, etc? This will let in unwanted ambient air, affecting control, efficiency and energy usage.
- ✓ Check – are exhaust air and fresh air ductwork properly sealed from plant room and other parts of the building?
- ✓ Check – the above should be checked by measuring plant room and pool hall air temperatures. If the plant room is acting as a plenum chamber both temperatures should correspond. If the plant room air temperature is lower, then ambient air is leaking in. This leak should be located and rectified.
- ✓ Check – are all air inlets and outlets free from obstructions? Are exhaust air and fresh air grilles adequately separated and not allowing recirculation from exhaust to inlet?
- ✓ Check – are air filters clean?
- ✓ Action – measure air volumes and commission fan speeds.

#### Pool water

- ✓ Check – is pool cover installed and used?

#### LPHW (AA+LPHW models only)

- ✓ Check – is LPHW connected correctly and insulated?
- ✓ Check – is LPHW flow rate correct?
- ✓ Check – size and type of LPHW heat source?
- ✓ Record – LPHW flow and return temperatures with air heat exchanger in operation.

#### Electrical

- ✓ Check – is electric installation complete?
- ✓ Check – is local isolator present?
- ✓ Check – is MCB suitable for the Variheat model installed?
- ✓ Record – MCB details
- ✓ Check – is fan rotation direction correct?
- ✓ Record – which customer terminals are in use.
- ✓ Record – compressor and fan running amps.
- ✓ Check – is auto-restart on power loss set to On or Off?

**Heat pump**

- ✓ Check: Are all heat exchangers in good condition?
- ✓ Check: Is condensate connected correctly?
- ✓ Record: Confirm refrigeration operating pressures.

**Controls**

- ✓ Check – function of touchscreen.
- ✓ Check and record – Recalibrate sensors, if necessary. (Ensure Variheat has been running for at least 30 minutes before calibration).
- ✓ Check and record – User Settings and record.
- ✓ Check – Time clock or remote override settings.
- ✓ Check – is auto-restart on power loss set to On or Off?

**Commissioning report**

- ✓ Action – complete commissioning report with all details.
- ✓ Check – Variheat is fully operational following commissioning.
- ✓ Check – operator has access to User instructions.

**Operator handover**

When commissioning is complete and there are no outstanding actions to complete, the Variheat is ready to be handed over to the operator. The operator should be made aware of the user instructions and familiarised with the basic controls on the Home screens. The operator should be made aware of the ongoing maintenance requirements. (See 4.1.)

**4.1 MAINTENANCE**

**Operations carried out during a planned maintenance visit are as follows:**

1. Replace all belts & filters where fitted.
2. Check operation and condition of all fans and compressors.
3. Check capacitor tolerances.
4. Check condition of all heat exchangers/evaporators.
5. Check refrigeration system parameters.
6. Check operation of control valves.
7. Check for water leaks.
8. Check drip trays and internal drain lines for blockages and clear.
9. Check operation of controls and calibrate as necessary.
10. Check operation of interlocks in use.
11. Final check on overall operation of unit.
12. Indicate on report any faults found or causes for concern.

**Frequencies recommended are as follows:**

Model	Light/Medium use	Heavy use
Variheat		
AA600 - AA900	1 to 2 visits per year	2 to 3 visits per year

Filters may need more frequent inspection.

In order to comply with European Union F-Gas regulations, it is necessary to leak test Variheat systems with R454C refrigerant annually. The operator of the unit is responsible for seeing that this test is carried out.

## 4.2 CIRCUIT DIAGRAMS

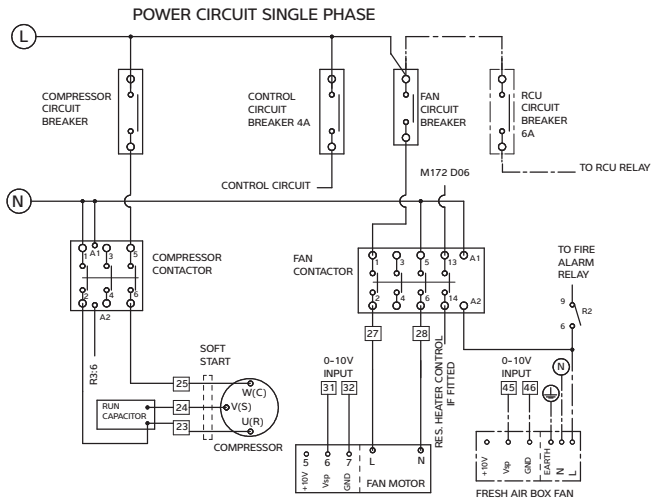

Model	Fan MCB Single phase	Compressor MCB
		Device value
AA600AVHX(F)	10A	16A
AA900AVHX(F)	10A	20A

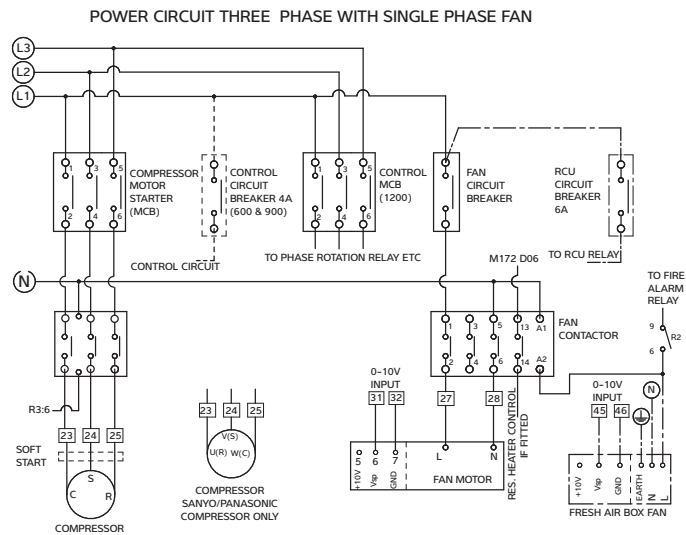

Model	Fan MCB Single phase	Compressor MCB	
		Tripping current	Setting value
AA600BVHX(F)	10A	5.62A	4.7A
AA900BVHX(F)	10A	5.2A	4.4A

## CONTROL CIRCUIT DIAGRAM AA MODELS

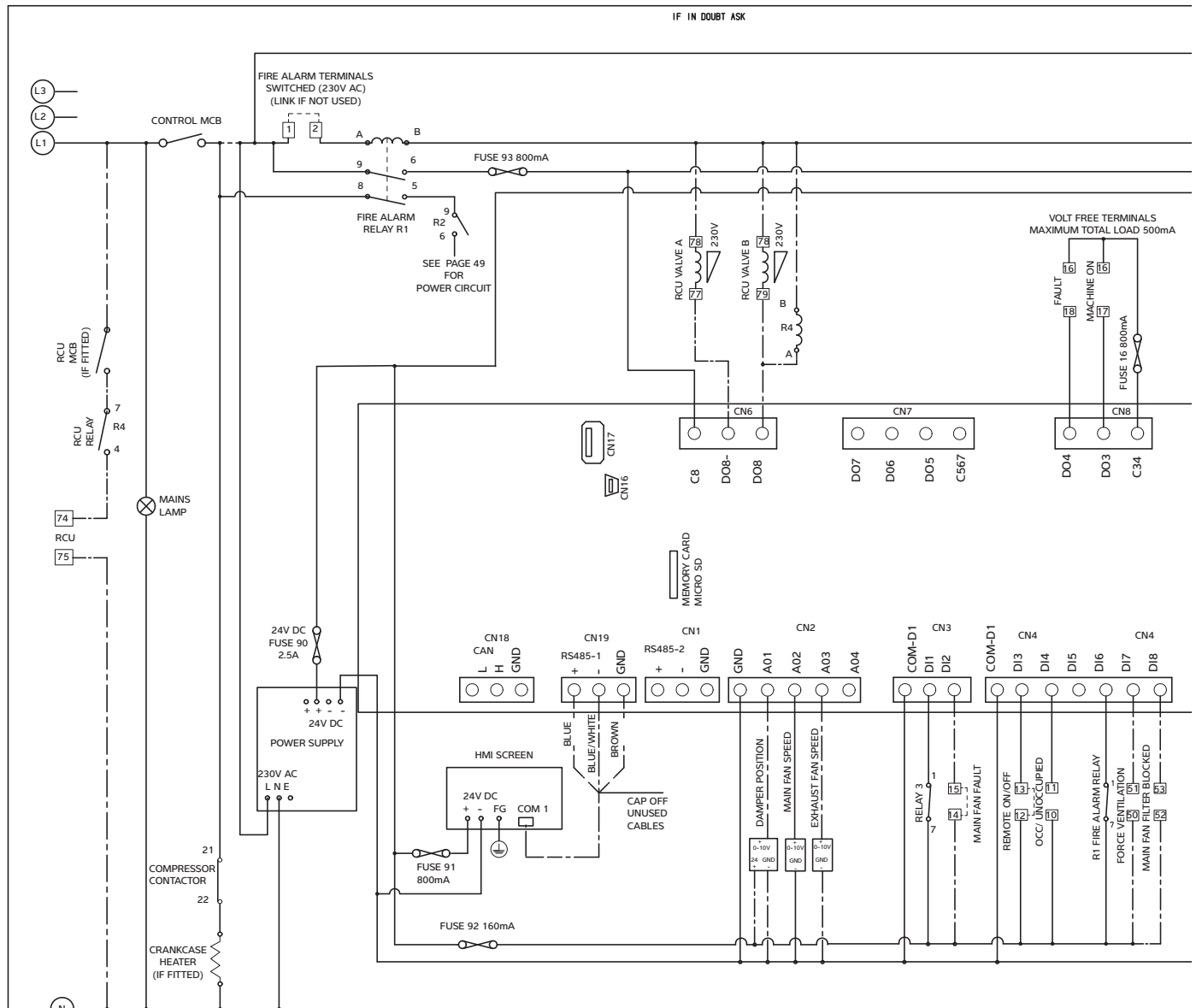

### NOTES

15 = DIN RAIL MOUNTED TERMINAL BLOCK NUMBERS

2. IF REMOTE OCC/UNOCC FEATURE USED  
 a) FORCE TIME CLOCK TO 'UNOCCUPIED'  
 b) 10/11 N/O = 'UNOCCUPIED'  
 c) 10/11 N/C = 'OCCUPIED'

----- = OPTIONS

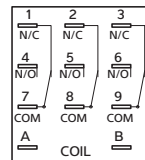

STANDARD RELAY FORMAT

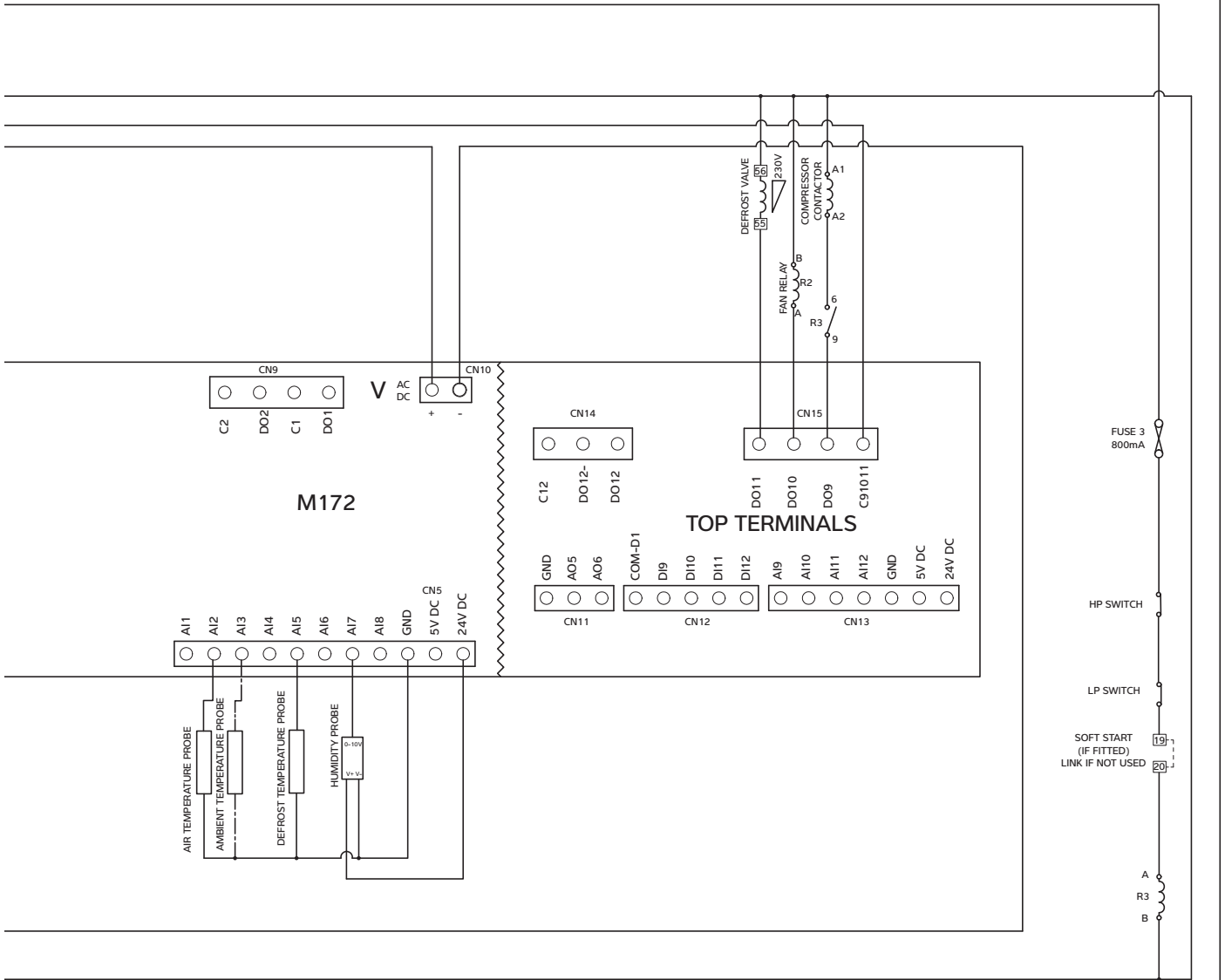

# VARIHEAT AA SYSTEM OWNER INSTALLATION MANUAL

## CONTROL CIRCUIT DIAGRAM AA+LPHW MODELS

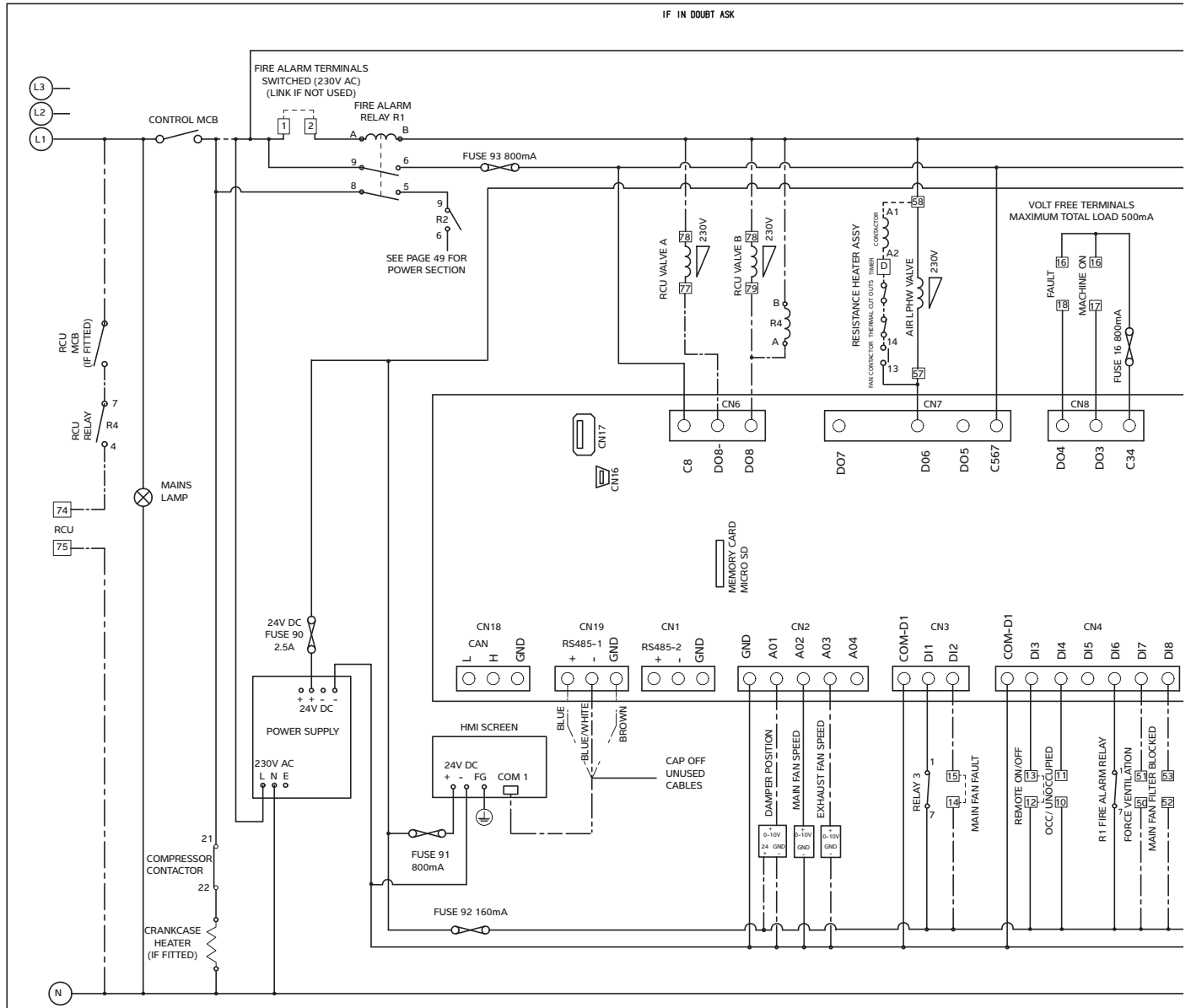

### NOTES

15 = DIN RAIL MOUNTED TERMINAL BLOCK NUMBERS

2. IF REMOTE OCC/UNOCC FEATURE USED  
 a) FORCE TIME CLOCK TO 'UNOCCUPIED'  
 b) 10/11 N/O = 'UNOCCUPIED'  
 c) 10/11 N/C = 'OCCUPIED'

--- = OPTIONS

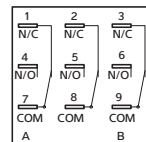

STANDARD RELAY FORMAT



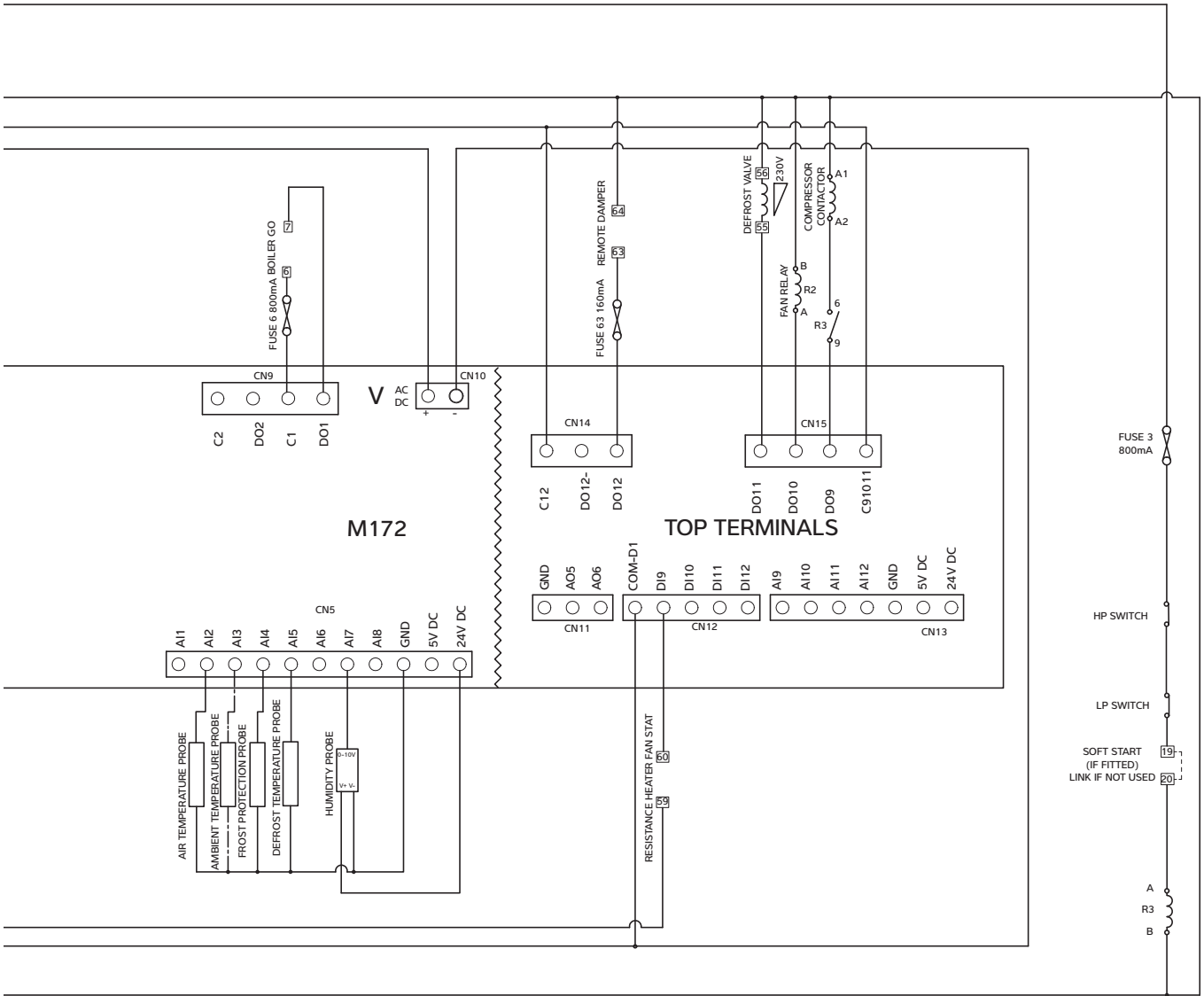

5.0 DATA SHEET

Specifications	Units	AA600A AA600B	AA900A AA900B
<b>Dehumidification</b>			
Heat pump dehumidification 30°C/60% RH	L/h	4.6	6.5
Total at 18°C dew point (summer) - if fresh air option fitted	L/h	5.2	7.3
Total at 7°C dew point (winter) - if fresh air option fitted	L/h	6.5	9.0
<b>Heat to air</b>			
Heat pump heat recovery	kW	5.1	7.1
Standard LPHW at 80°C flow -see section 5.1.1	kW	11.0	13.5
Upgraded LPHW at 55°C flow - see section 5.1.2	kW	9.4	11.5
Total - std. LPHW + heat recovery	kW	14.0	18.6
<b>LPHW data - AA+LPHW models only</b>			
Recommended min. boiler capacity (standard LPHW at 80°C)	kW	11.0	13.5
Recommended min. boiler capacity (upgraded LPHW at 55°C)	kW	9.4	11.5
Flow rate - standard LPHW - see section 5.1.1	L/min	10	10
Flow rate - upgraded LPHW - see section 5.1.2	L/min	14	24
Pressure drop at rated flow rate - standard LPHW	m/kPa	1.6/15.7	1.6/15.7
Pressure drop at rated flow rate - upgraded LPHW	m/kPa	1.6/15.7	4.1/40.2
LPHW system volume	L	1.6	1.6
Maximum working pressure	bar	6	6
<b>Electrical data</b>			
Typical high pressure system with constant flow fan	kW	2.1	2.8
Typical low pressure system with constant flow fan	kW	1.8	2.4
Minimum supply capacity (FLA) 230V/1N/50Hz	A	14	19.3
Minimum supply capacity (FLA) 400V/3N/50Hz	A	8.4	10
Maximum supply fuse 230V/1N/50Hz	A	20	32
Maximum supply fuse 400V/3N/50Hz	A	10	16
<b>Main fan data - constant flow fans</b>			
Design air flow (anemometer @ air on filter, wet evaporator) ± 10%	m <sup>3</sup> /h	2000	2500
Maximum external static pressure standard LPHW	Pa	330	220
Maximum external static pressure upgraded LPHW	Pa	320	208
Design running amps - 230V/1N fans	A	3.8	4.7
FLA - 230V/1N fans	A	7.6	7.6
<b>Optional fresh air module</b>			
Air flow	m <sup>3</sup> /h	0-900	0-900
Maximum external static pressure	Pa	100	100
Heat required for fresh air at -5°C	m <sup>3</sup> /h/kW	150/1.8	200/2.3
<b>Optional electric air heater module - (separate power supply)</b>			
Nominal power (two options per model)	kW	6 or 12	6 or 12
Minimum supply capacity (FLA) 230V/1N/50Hz	A	30 or 60	30 or 60
Minimum supply capacity (FLA) 400V/3N/50Hz	A	9 or 18	9 or 18
Maximum supply fuse 230V/1N/50Hz	A	32 or 63	32 or 63
Maximum supply fuse 400V/3N/50Hz	A	10 or 20	10 or 20
<b>Compressor data</b>			
Nominal power consumed	kW	1.5	2.0
Nominal RLA - 230V/1N/50Hz	A	8.0	12.4
Starting current 230V/1N/50Hz	A	55	76
Starting current 230V/1N/50Hz (with soft start)	A	26	31
Nominal RLA 400V-3N-50Hz	A	3.2	3.6
Starting current 400V/3N/50Hz	A	30	30
Starting current 400V/3N/50Hz (with soft start)	A	14	14
<b>General data</b>			
<b>Hermetic refrigeration system</b> - gas charge (R454C)	kg	1.8	1.85
Typical weight - unpacked	kg	170	171
Minimum area requirement	m <sup>2</sup>	31.0	32.7

For accurate project sizing consult the Dantherm Group or your local representative  
 Mode A: heat recovery biased to pool water when pool water temperature not satisfied  
 Mode B: heat recovery biased to pool hall air when pool water temperature satisfied  
 R454C global warming potential (GWP): 146

1L/minute = 0.22gallon/minute (Imperial)  
 1mm water gauge = 9.8Pa  
 1m head = 9.8kPa

## 5.1 LPHW HEATING DATA - VARIHEAT WITH STANDARD AIR HEATER

		flow °C	<b>80</b>	70	60	50	45
<b>AA600</b>	standard air heating capacity	kW	<b>11.0</b>	8.8	6.6	4.4	3.3
	recommended boiler capacity	kW	<b>11.0</b>	8.8	6.6	4.4	3.3
	LPHW flow rate	L/min	<b>10</b>	10	10	10	10
	return temperature	°C	<b>64.2</b>	57.4	50.5	43.7	40.3
		flow °C	<b>80</b>	70	60	50	45
<b>AA900</b>	standard air heating capacity	kW	<b>13.5</b>	10.8	8.1	5.4	4.1
	recommended boiler capacity	kW	<b>13.5</b>	10.8	8.1	5.4	4.1
	LPHW flow rate	L/min	<b>10</b>	10	10	10	10
	return temperature	°C	<b>60.7</b>	54.5	48.4	42.3	39.2

## 5.2 LPHW HEATING DATA - VARIHEAT WITH UPGRADED AIR HEATER (WHERE MODEL NUMBER INCLUDES +EC LPHW)

		flow °C	65	<b>60</b>	55	50	45
<b>AA600</b>	upgraded air heating capacity	kW	12.8	<b>11.0</b>	9.2	7.3	5.5
	recommended boiler capacity	kW	12.8	<b>11.0</b>	9.2	7.3	5.5
	LPHW flow rate	L/min	14	<b>14</b>	14	14	14
	LPHW return temperature	°C	51.9	<b>48.7</b>	45.6	42.5	39.4
		flow °C	65	<b>60</b>	55	50	45
<b>AA900</b>	upgraded air heating capacity	kW	15.8	<b>13.5</b>	11.3	9.0	6.8
	recommended boiler capacity	kW	15.8	<b>13.5</b>	11.3	9.0	6.8
	LPHW flow rate	L/min	14	<b>14</b>	14	14	14
	LPHW return temperature	°C	48.9	<b>46.2</b>	43.5	40.8	38.1

Data based on air 30°C, pool water 28°C

6.0 DIMENSIONS

600/900 vertical, upflow versions

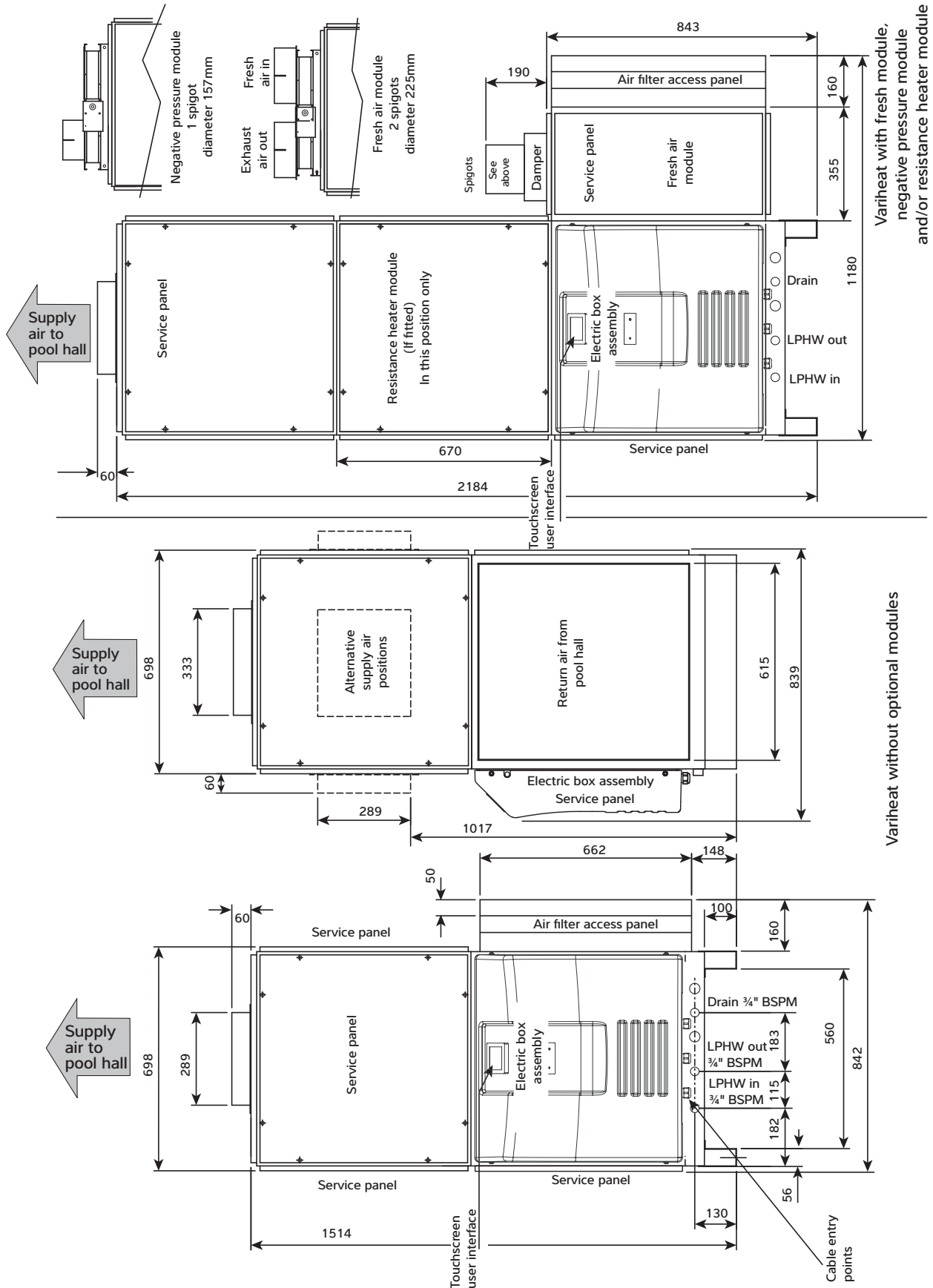

600/900 vertical, downflow versions

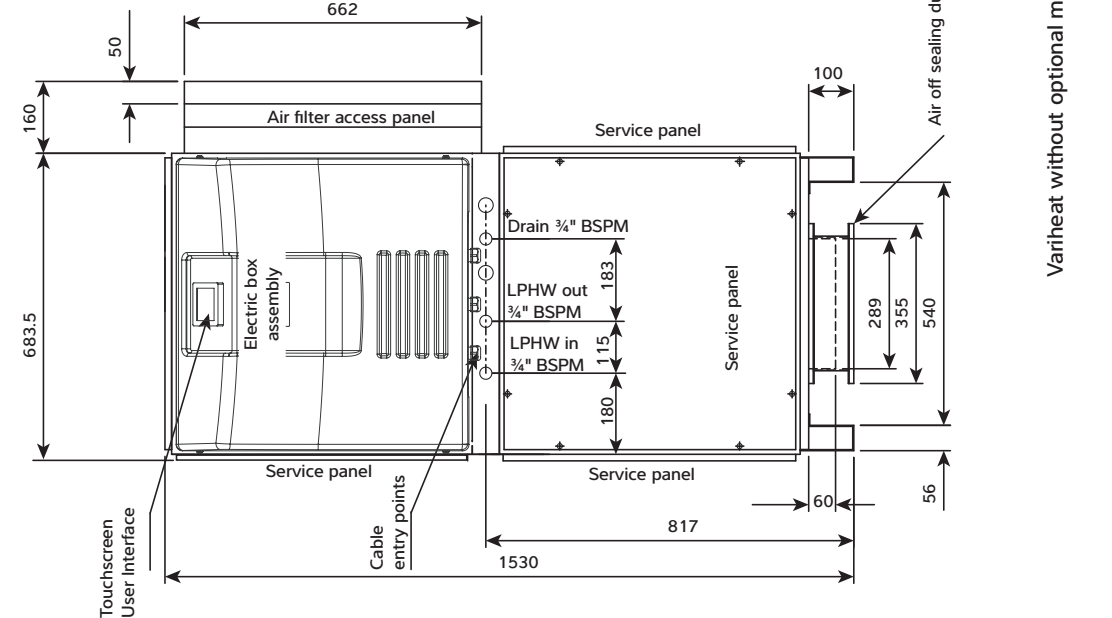
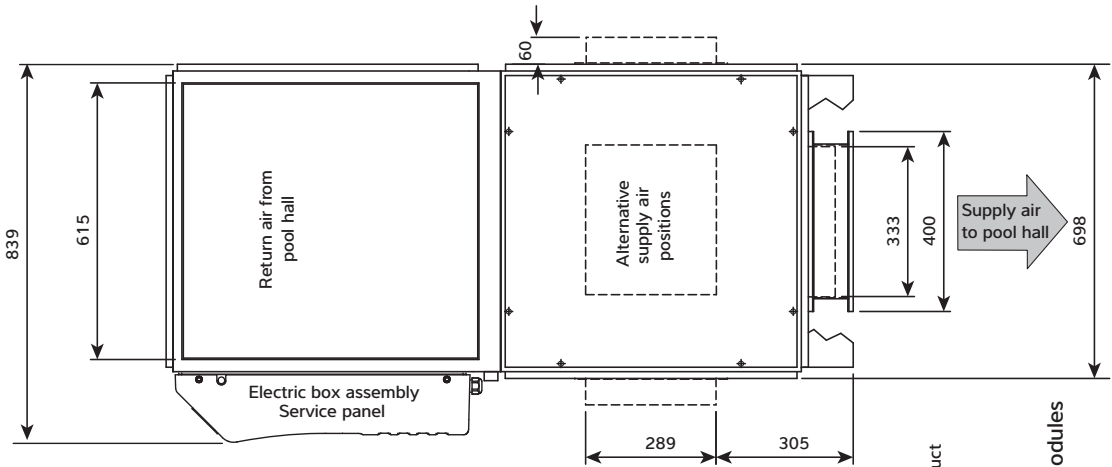
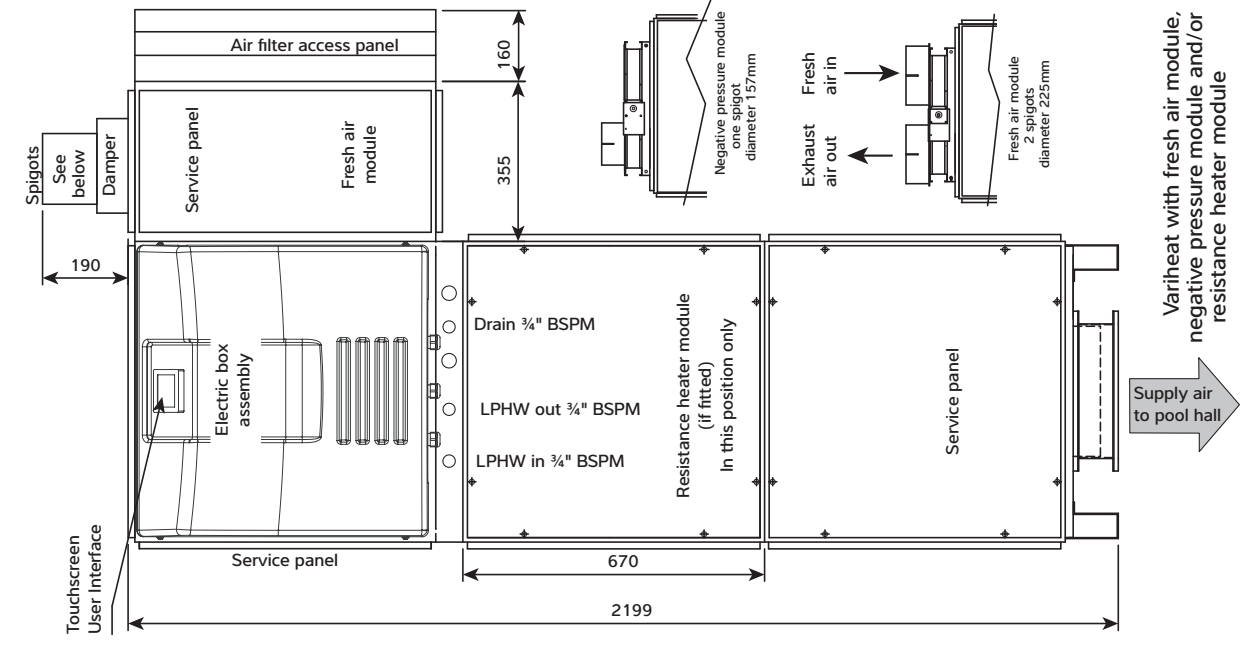

600/900 horizontal versions

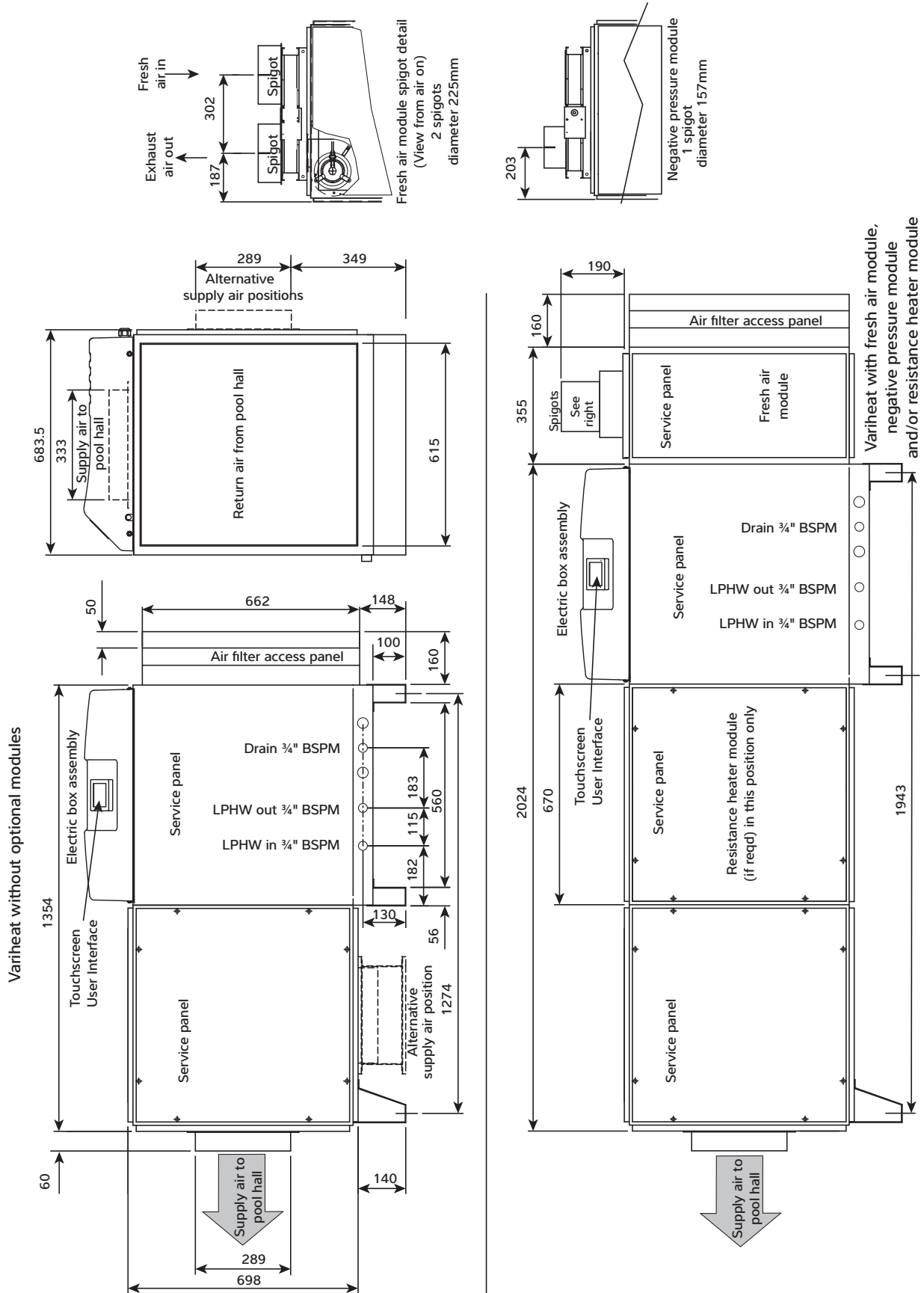

600/900 horizontal versions viewed from opposite side

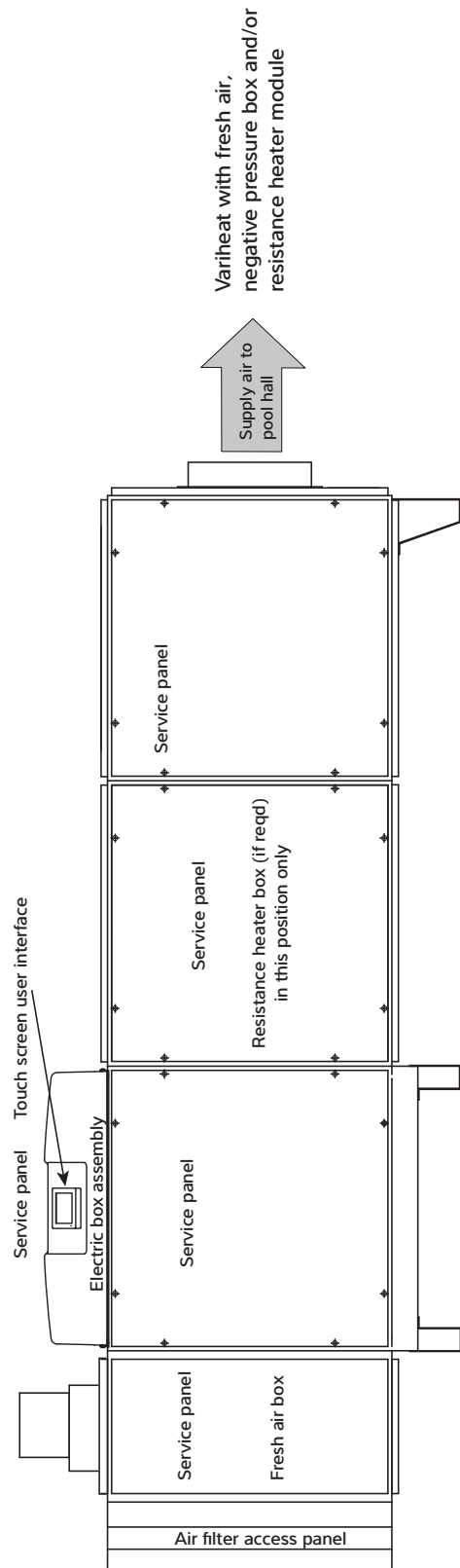
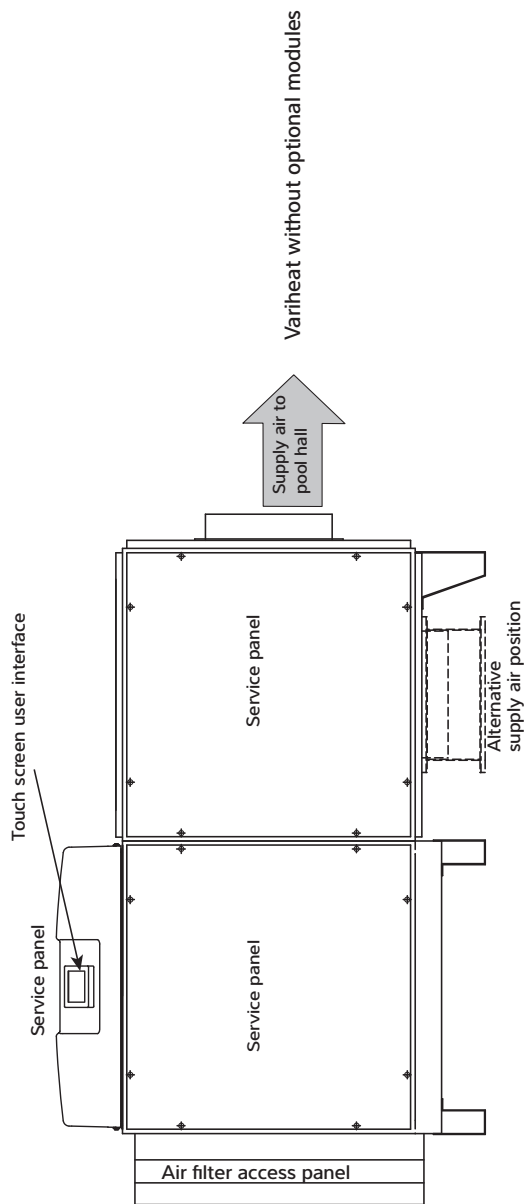

Bottom outlet versions, showing duct to floor detail

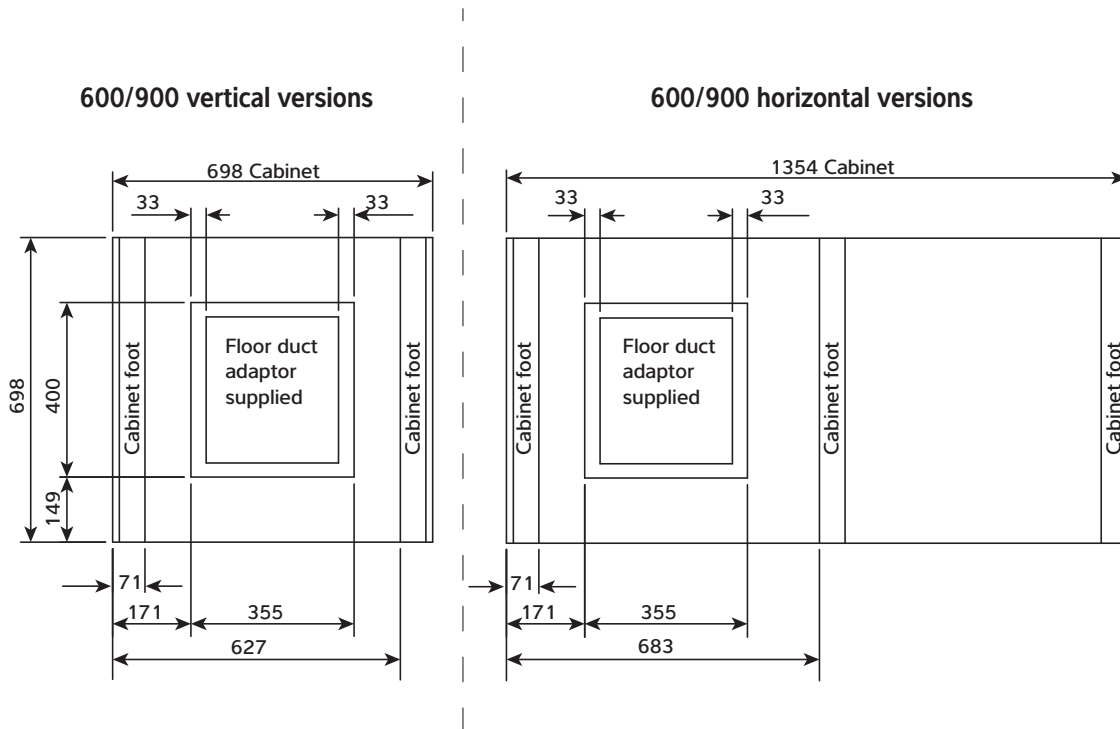



## 7.0 VARIHEAT CONFIGURATIONS

The Variheat can be supplied in a range of physical configurations.

Versions with pipe connections on the opposite face are also available. See separate configuration guide

### Variheat without fresh air module

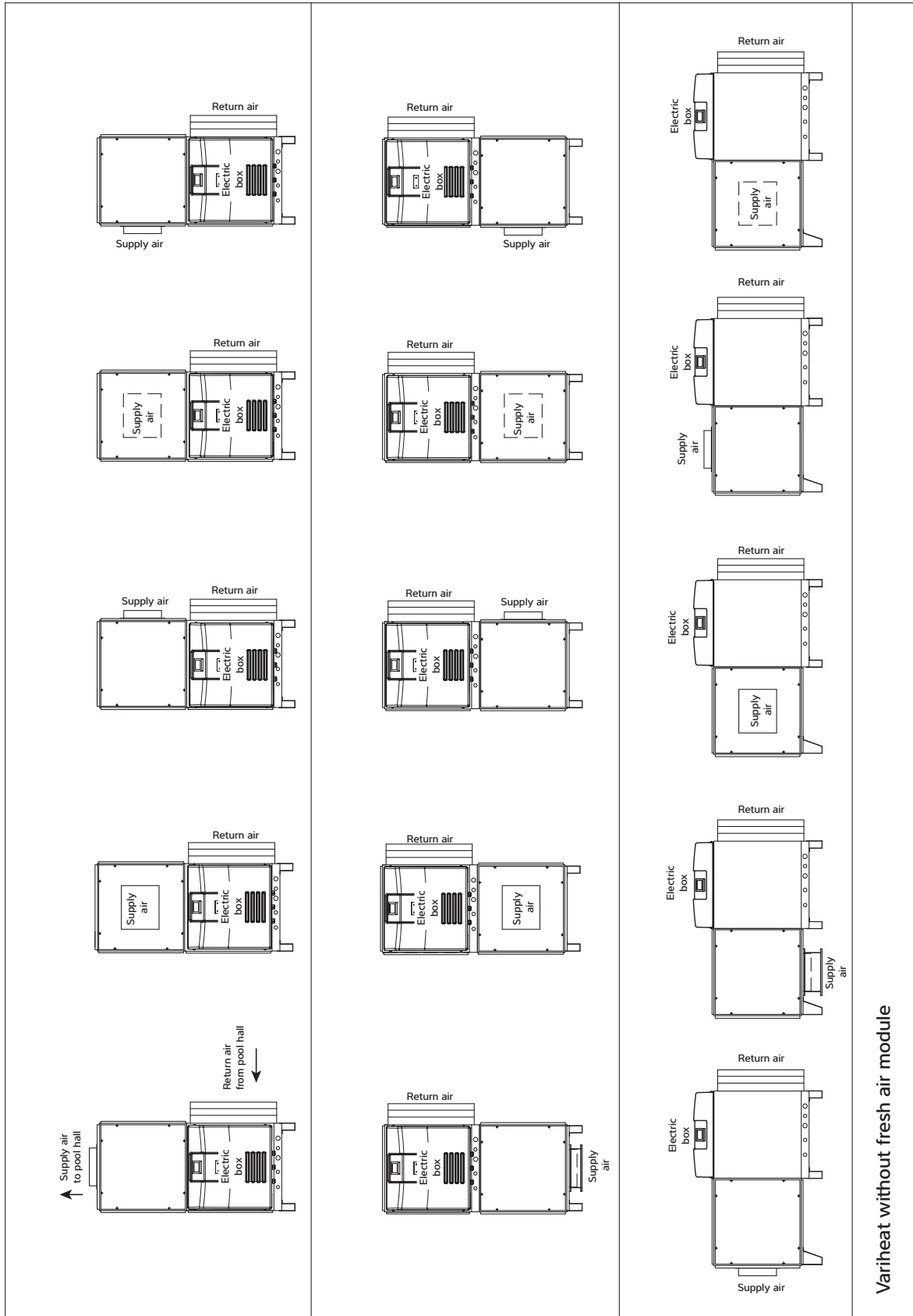

Variheat without fresh air module

Variheat with fresh air module

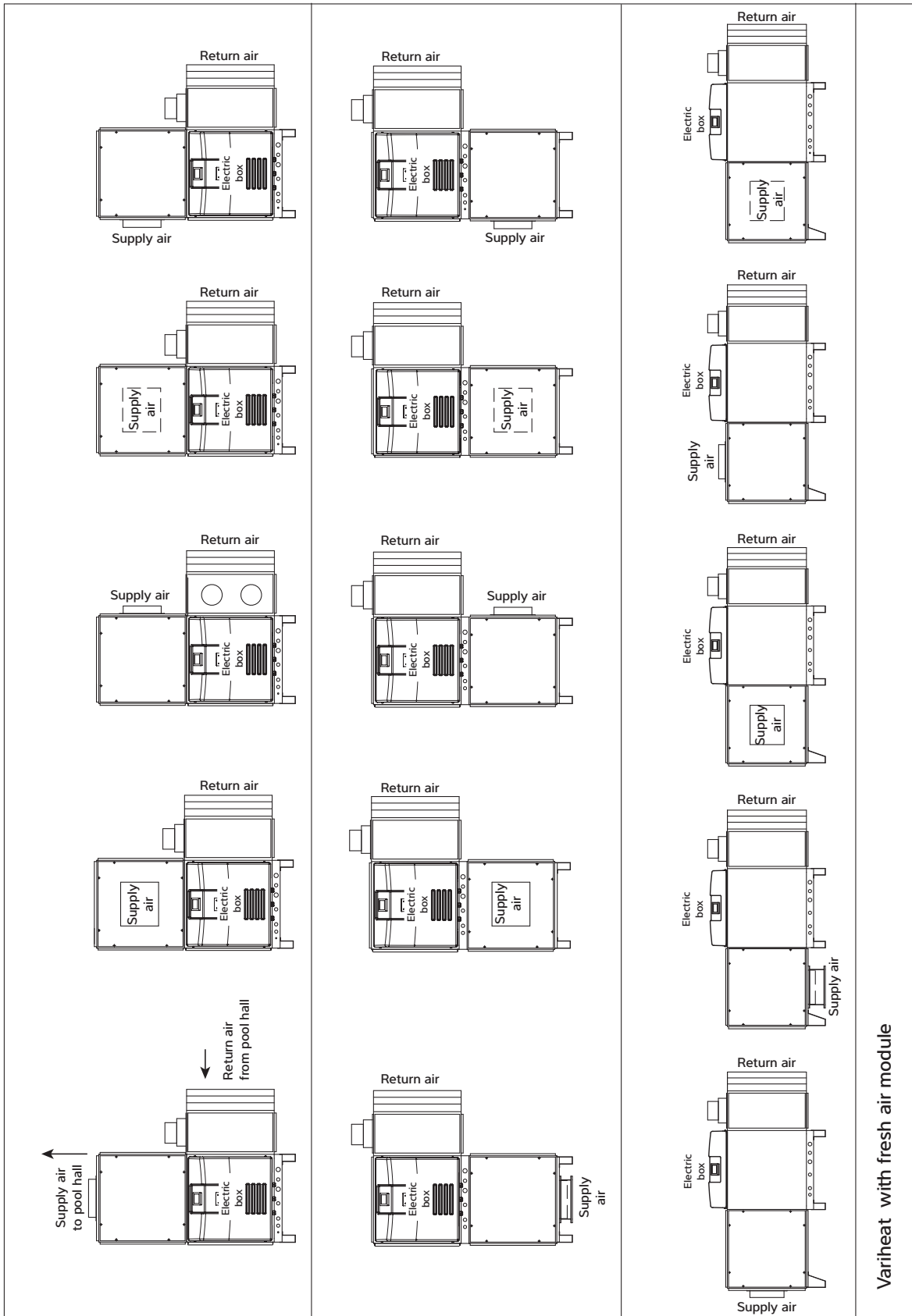

Variheat with fresh air module

Variheat with fresh air module and electric heater module

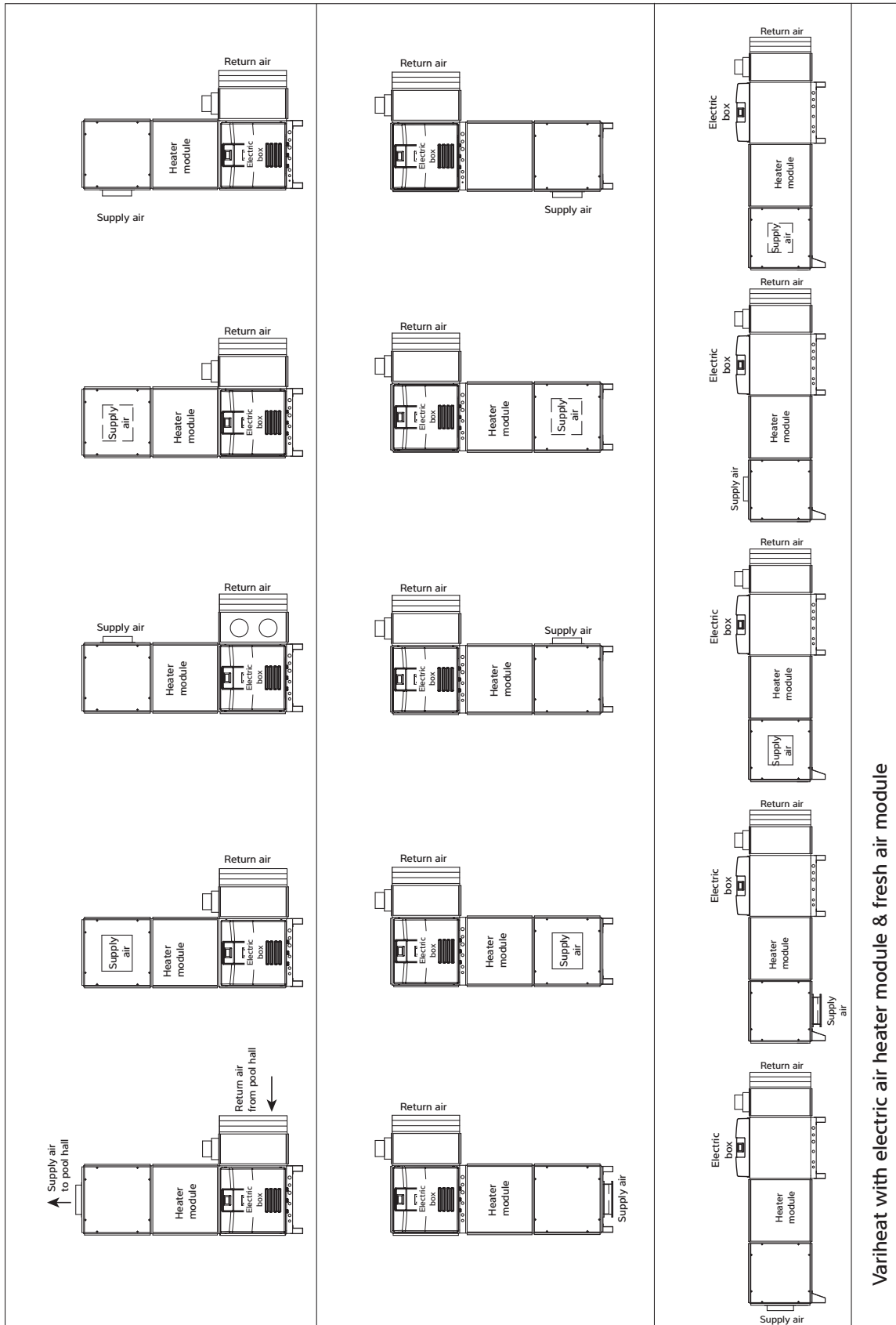

Variheat with electric air heater module & fresh air module

**8.0 WARRANTY CONDITIONS**

One year manufacturer’s warranty is valid from the date of commissioning or 18 months from delivery, whichever is sooner.

Where commissioning is provided in the UK and Ireland, this must be carried out by factory trained and approved personnel.

The following exclusions apply to the Warranty given by Dantherm Ltd. No claims will be accepted if :

1. The heat pump is installed in any way that is not in accordance with the current procedures as defined by Dantherm Ltd.
2. The heat pump has not been maintained in accordance with service requirements in section 4.1 Regular Planned Maintenance.
3. The heat pump has been worked upon or is adjusted by anyone other than a person authorised to do so by Dantherm Ltd.
4. The heat pump is incorrectly sized for the application.
5. The water flow through the machine is outside the specified limits.
6. The water pH level and/or chemical balance is outside the following limits:

Acidity pH	pH	7.2 - 7.8
Total Alkalinity, as CaCO3	ppm	80 - 120
Total Hardness, as CaCO3	ppm	150 - 250
Total Dissolved Solids	ppm	1000
Maximum Salt Content	ppm	8000
Free Chlorine Range	ppm	1 - 2 Domestic
Free Chlorine Range	ppm	3 - 6 Commercial
Superchlorination	max	30ppm for 24 hrs
Bromine	ppm	2 - 5
Baquacil	ppm	25 - 50
Ozone	ppm	0.9 Max
Maximum Copper Content	ppm	1
Aquamatic Ionic Purifier	ppm	2 Max

7. The heat pump has suffered frost damage.
8. The electrical supply is insufficient or in any way incorrect.
9. The fan amps and duct pressure are outside the specified limits.
10. The air flow to and from the machine is outside the specified limits.
11. Corrosion is present due to poor air quality that has not been attended to.

**If in doubt or if advice is required please contact the Dantherm Group UK Service Department by calling 01621 856611 (option 4) or emailing [service.department@dantherm.com](mailto:service.department@dantherm.com)**

**Note:** The Reply Paid Warranty Registration Card must be returned, to ensure that the correct warranty is given. If you do not find a Registration Card with your heat pump please contact the Dantherm Group UK Service Department giving your name, address and serial number of your heat pump. A card will be sent to you for completion.

Please give **MODEL NUMBER** and **SERIAL NUMBER** of your heat pump when making technical or service enquiries. This will assist in correct diagnosis and ensure service can be provided with the minimum delay.

## 9.0 HEAT PUMP RECORD LOG

In order to comply with F-Gas regulations, it is necessary for hermetically sealed systems with more than 6kg refrigerant to be leak tested annually.

The operator of the heat pump is responsible for seeing that the test is carried out.

A sample log sheet can be seen below.

Dantherm Ltd. is an F-Gas registered company. Certificate number REF1011570.

GENERAL INFORMATION				
Plant name				Serial number
Location of plant				
Plant operator <sup>1</sup>				
Operator contact <sup>2</sup>				
Refrigerant type				Refrigerant quantity installed (kg)
Plant manufacturer	Dantherm Ltd			Year of installation
REFRIGERANT ADDITIONS				
Date	Engineer <sup>3</sup>		Amount added kg	Reason for addition
	Company	Name		
REFRIGERANT REMOVALS				
Date	Engineer <sup>3</sup>		Amount removed kg	Reason for removal What done with recovered refrigerant
	Company	Name		
NAME AND ADDRESS OF RECYCLING OR RECLAMATION FACILITY				CERTIFICATE NUMBER IF APPLICABLE
LEAK TESTS				
Date	Engineer <sup>3</sup>		Test result	Follow up action required
	Company	Name		
FOLLOW UP ACTIONS				
Date	Engineer <sup>3</sup>		Related to test on	Actions taken
	Company	Name		
TESTING OF AUTOMATIC LEAK DETECTION SYSTEM (IF FITTED)				
Date	Engineer <sup>3</sup>		Test result	Comments
	Company	Name		
PERIODS OF NON-USE				

1 Name and address of company operating plant.

2 Contact details of operator's nominated person responsible for F-Gas compliance.

3 Company and technician carrying out work, with details to provide evidence of compliance.

**IMPORTANT** The company carrying out refrigerant checking and removals, and the owner of the equipment need to keep records for FIVE YEARS.

When this heat pump is decommissioned the refrigerant gas is to be recovered in accordance with current environmental legislation.





**Dantherm A/S**

Marienlystvej 65  
DK-7800 Skive  
Denmark  
t. +45 96 14 37 00

**Dantherm Ltd.**

Unit 12, Galliford Road  
Maldon CM9 4XD  
United Kingdom  
t. +44 (0)1621 856611

**Dantherm GmbH**

Oststraße 148  
22844 Norderstedt  
Germany  
t. +49 40 526 8790

**Dantherm S.p.A.**

Via Gardesana 11  
37010 Pastrengo (VR)  
Italy  
t. +39 045 6770533

**Dantherm Sp. z o.o.**

ul. Magazynowa 5a  
62-023 Gądki  
Poland  
t. +48 61 65 44 000

**Dantherm SP S.A.**

C/Calabozos 6  
(Polígono Industrial)  
28108 Alcobendas, Madrid  
Spain  
t. +34 91 661 45 00

**Dantherm SAS**

23 rue Eugène Hénaff  
69694 Vénissieux Cedex  
France  
t. +33 4 78 47 11 11

**Dantherm AS**

Løkkeåsveien 26  
3138 Skallestad  
Norway  
t. +47 33 35 16 00

**Dantherm AB**

Fridhemsvägen 3  
602 13 Norrköping  
Sweden  
t. +46 (0)11 19 30 40

**Dantherm LLC**

Transportnaya 22/2  
142800, Stupino  
Moscow  
Russia  
t. +7 (495) 642 444 8

**MCS China**

Unit 2B, No. 512  
Yunchuan Road  
Baoshang, Shanghai, 201906  
China  
t. +8621 61486668

**AirCenter AG**

Täferstrasse 14  
CH-5405 Baden Dättwil  
Switzerland  
t. +41 43 500 00 50

**Contact:**

**Dantherm Ltd.**

Unit 12, Galliford Road  
Maldon CM9 4XD  
United Kingdom  
t. +44 (0)1621 856611

KEEP UPDATED

**FOLLOW US ON:**

