



I-PAC / I-PAC+ inverter heat pumps

IPT 8, 12, 16, 22, 28

Owner Installation Manual 1005494 Issue 5



HEALTH AND SAFETY WARNING

This product contains electrical and rotational equipment. **ONLY** competent trained people should work on this device, and must be isolated electrically before removing access panels.

This appliance can be used by children from 8 years and above and persons with reduced physical, sensory or mental capabilities or lack of experience and knowledge if they have been given supervision or instruction concerning use of the appliance in a safe way and understand the hazards involved. Children should not play with the appliance. Cleaning and user maintenance shall not be made by children without supervision.



CONTENTS

HEALTH AND SAFETY WARNING	2	3.10 INSTALLING THE OPTIONAL REMOTE CONTROLLER	20
1.0 INTRODUCTION	4	4.0 USING YOUR HEAT PUMP	22
1.1 FOREWORD	4	4.1 THE KEY PAD	22
1.2 WARNINGS	4	4.2 OPERATING INSTRUCTIONS	23
2.0 ABOUT YOUR HEAT PUMP	8	4.3 USING THE APP	24
2.1 TRANSPORTATION	8	4.4 USING THE OPTIONAL REMOTE CONTROLLER	30
2.2 ACCESSORIES	8	4.5 THE KEY PAD	30
2.3 OPTIONAL ACCESSORIES	9	4.6 OPERATING INSTRUCTIONS	31
2.4 FEATURES	10	5.0 TESTING	32
2.5 OPERATING CONDITIONS AND RANGE ...	10	5.1 HEAT PUMP MALFUNCTION	32
2.6 OPERATING MODES	10	5.2 PROTECTION CODES	33
3.0 INSTALLATION	11	5.3 FAULT CODES	34
3.1 POSITIONING AND AIRFLOW	11	6.0 MAINTENANCE	35
3.2 REFRIGERANT TYPE AND INSTALLED LOCATION	14	7.0 TROUBLE SHOOTING COMMON FAULTS	35
3.3 POOL WATER CIRCUIT	15	8.0 DATASHEETS	36
3.4 PLUMBING	16	9.0 DIMENSIONS	39
3.5 INITIAL CHECKS	16	9.1 DIMENSIONS	40
3.6 ELECTROLYTIC CORROSION IN SWIMMING POOLS	17	10.0 WINTERISATION PROCEDURE	41
3.7 ELECTRIC WIRING AND SUPPLY	17	10.1 START UP PROCEDURE AFTER WINTERISATION	41
3.8 CONNECTING THE HEAT PUMP TO THE POWER SUPPLY	18	11.0 WARRANTY CONDITIONS	42
3.9 POOL PUMP SYNCHRONISATION TERMINALS P1 AND P2	19	12.0 DECLARATION OF CONFORMITY	43

1.0 INTRODUCTION

1.1 FOREWORD

Thank you for choosing this product, which is designed for quiet and energy efficient operation. It is the ideal way to heat your pool in an environmentally friendly way.

This guide provides information needed to install and operate the product effectively. Please ensure you read this manual and use the correct installation and operating procedures.

This manual is intended for installers and users. Read the entire manual before using the heat pump. Awareness of the correct operating procedure for the machine and any safety devices is important, to avoid damage or injury.

The appliance can be used by children aged from 8 years and above and persons with reduced, physical, sensory or mental capabilities or lack of experience and knowledge if they have been given supervision or instruction concerning use of the appliance in a safe way and understand the hazards involved. Children shall not play with the appliance. Cleaning and user maintenance shall not be made by children without supervision.

1.2 WARNINGS

Important safety information is contained in this manual and marked on the heat pump.

Please read and follow all safety advice.

The refrigerant used in this heat pump is R32. This refrigerant is environmentally friendly, but safety instructions must be strictly adhered to.



R32 Gas

The WARNING sign denotes a hazard. It calls attention to a procedure or practice, which if not adhered to could result in injury. Warning signs and procedures must be complied with.

If a refrigerant leak is suspected stop using the heat pump and contact Dantherm Group UK service.

service.department@dantherm.com

Take the following precautions in order to avoid any danger:

REFRIGERANT SAFETY:

This heat pump contains R32 refrigerant. Work on the refrigeration system, repair and disposal must be carried out by appropriately qualified and registered engineers.

Repair, service and disposal must be carried out in the EU by F-Gas registered engineers.

Completely de-gas the refrigerant before any brazing is performed. Brazing can only be carried out by technicians trained to EU 517/2014.

Risk assessments must be carried out before maintenance or repairs are started.

Appropriate safety measures and risk assessments must be taken before work commences.

Do not attempt to work on the equipment by yourself.

Consult the qualified engineer undertaking the work to establish all requirements before work commences.

ACTIONS TO AVOID (OPERATION AND HANDLING):

Be especially careful when handling the heat pump, not to cause any damage that may result in leakage of the cooling circuit.

Do not use means to accelerate the defrosting process or to clean, other than those recommended by the manufacturer.

Do not pierce or burn.

IN CASE OF FIRE:

Toxic fumes may occur in the event of fire. You must leave the room as quickly as possible in the event of fire.

LOCATION REQUIREMENTS:

The heat pump contains R32 refrigerant so the following location requirements must be fulfilled:

The heat pump must be kept away from sources of fire or naked flames.

The heat pump must be installed, operated and stored where the floor area is larger than the minimum requirement., see section 3.2.

The heat pump shall be stored in a room without continuously operating ignition sources (for example: open flames, an operating gas appliance or an operating electric heater).

Keep the ventilation openings clear of obstruction during operation.

Do not use or store combustible gas or liquids near the heat pump.

Check if there are any local regulations, which you must comply to, when installing or storing the heat pump.

Be aware that refrigerants may not contain an odour.

OWNER/INSTALLATION MANUAL

Installation must be carried out by competent people, in accordance with this manual.

INSTALLATION:

Read the instructions before installation, use and maintenance.

If R32 gas leaks during the installation process, stop the installation immediately and call the service centre.

If a repair is required, please contact the nearest after-sales service centre.

To avoid over heating or over cooling of pool water check and set the temperature on the control panel.

The heating performance can be improved by insulating the flow and return pipework.

It is recommended that a cover is used on the swimming pool to reduce heat losses.

AIRFLOW:

The heat pump must have access to adequate airflow. See section 3.1.

Do not place obstructions that will block air flow near the inlet or outlet.

ELECTRICAL SAFETY:

Mains power isolator should be out of reach of children.

After a power cut, when the power supply is restored, the heat pump may start up without warning.

Electric storms can damage electronic equipment. Ideally the heat pump should be switched off at the mains.

HEAT PUMP MALFUNCTION:

WARNING: Isolate heat pump electrically and wait 3 minutes before removing panels or entering heat pump.

Refer to the user check list in section 5.2 and the error codes listed in section 5.3 before initiating a service call.

Do not attempt to interfere with any internal control settings as these have been factory calibrated and sealed.

Any sign of abnormal operation such as water dripping should be reported immediately to the installer. If in doubt or if advice is required contact the Service support team on telephone +44(0)1621 8566 11 (option 4).

MAINTENANCE:

Isolate the power supply of the heat pump and wait 3 minutes before cleaning examination or repair.

Please clean this machine with household detergents or clean water. NEVER use petroleum spirit, thinners or any similar fuel.





Check bolts, cables and connections regularly.

DISPOSAL:

Repair, service and disposal of redundant heat pumps must be completed by authorised technicians. It is illegal to allow refrigerant gases to escape to air.

Do not attempt to work on the equipment by yourself. Improper operation may cause danger.

 R32 Gas	Do not use means to accelerate the defrosting process or to clean, other than those recommended by the manufacturer.
	The appliance shall be stored in a room without continuously operating ignition sources (for example: open flames, an operating gas appliance or an operating electric heater).
	Do not pierce or burn.
	Be aware that refrigerants may not contain an odour.
	Appliance shall be installed, operated and stored in a room with a floor area larger than Xm^2 , where X is the "minimum area" shown in section 3.2 and section 8.0.

	The heat pump must be kept away from sources of fire or naked flames.
	The heat pump must be installed in well ventilated area. Closed areas are not permitted.
	Repair and disposal must be carried out by F-Gas registered engineers.
	Completely de-gas the refrigerant before any brazing is performed. Brazing can only be carried out by technicians trained to EU 517/2014.

OWNER/INSTALLATION MANUAL

2.0 ABOUT YOUR HEAT PUMP

2.1 TRANSPORTATION

Always keep the heat pump upright.

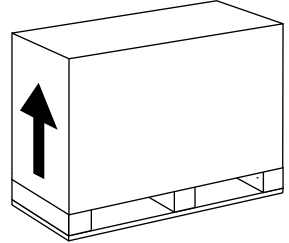

Do not lift the heat pump by the water inlet or outlet connections.

(If this is done the titanium heat exchanger inside the heat pump could be damaged).

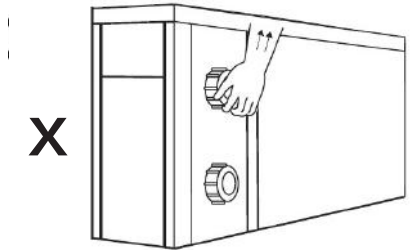

2.2 ACCESSORIES

These accessories are provided with the heat pump.

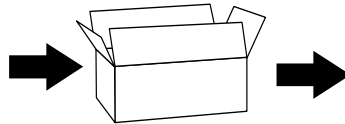
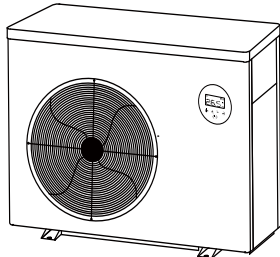

Water union connectors
2 x 1½,
2 x 50mm



Rubber Feet
(kit of 4)



Drainage kit



2.3 OPTIONAL ACCESSORIES

The following items are additional accessories available for purchase.

Remote controller kit for indoor installation.
(10m extension cable).



Winter cover.

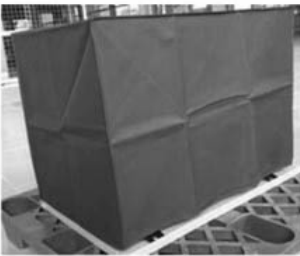

2.4 FEATURES

- Stepless DC inverter compressor
- EEV Technology (Electronic Equalisation Valve)
- Quick reverse cycle defrosting with 4-way valve
- High-efficiency twisted titanium heat exchanger
- High pressure and low pressure protection
- Soft start and wide voltage application
- Stable inverter control system

2.5 OPERATING CONDITIONS AND RANGE

Air temperature operating range:

I-PAC (IPT X models): -5-43°C

I-PAC+ (IPT Y models): -10-43°C



Water temperature setting range:

Heating: 18°C-40°C

Cooling: 12°C-30°C

2.6 OPERATING MODES

The heat pump has two modes: Boost mode and Whisper mode.

Mode	Modes	Characteristics
	Boost mode	Heating capacity: 20% to 100% capacity Intelligent optimization Fastest heating
	Whisper mode	Heating capacity: 20% to 80% capacity Sound level: 3dB(A) lower than Boost mode

3.0 INSTALLATION

Installation must only be attempted by competent personnel.

3.1 POSITIONING AND AIRFLOW



The heat pump must be positioned in a well ventilated area. Minimum distances between the heat pump and any obstructions are shown below.

- The heat pump must be fixed by M10 bolts to a concrete base or mounting brackets. These must be solid and fixed securely. Brackets must be corrosion proof.
- Do not block inlet or outlet grilles.

Airflow - general principles

The heat pump absorbs energy from the air drawn through it. To function effectively the heat pump must have access to the fresh air it needs.

- Air must not recirculate. The air leaving the heat pump must not be sucked back into the inlet.
- Air must not be restricted. The air volume must not be reduced.
- The minimum required distances shown below must be provided to minimise the risk of air recirculation or restriction and reduction in performance. Further examples are shown on the following page.

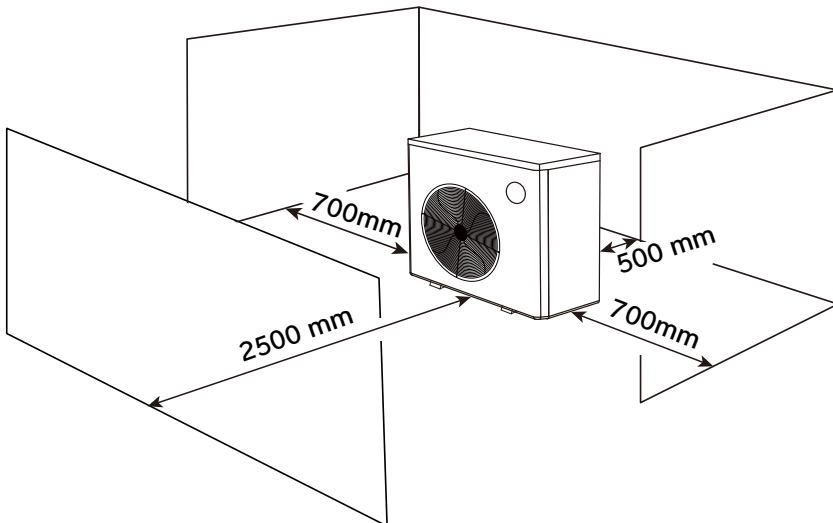

Possible positions of a Calorex heat pump

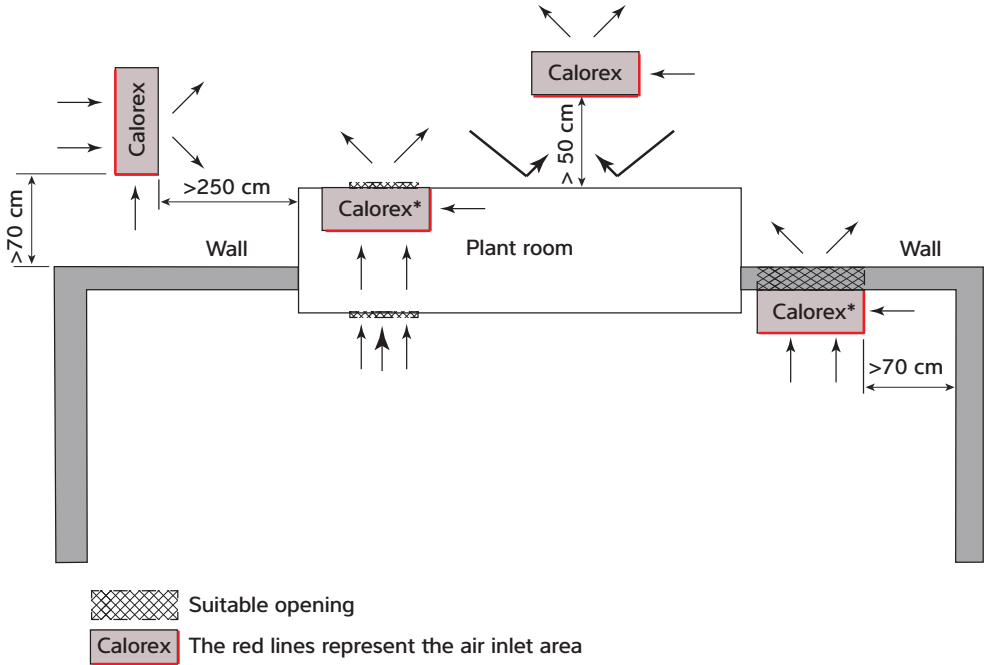

*** Controls are obscured by the wall. Connect to optional remote control panel or Wi-Fi before installing the heat pump in position.**

Required free areas to provide air flow to and from heat pumps when installed in an enclosed area or where required to pass air through a wall etc. Ensure the heat pump is sealed against the wall so the outlet air cannot recirculate. Ensure the hole through the wall is sealed to avoid the outlet air entering cavities and is smooth so the outlet air is not restricted.

Free area is the available area through which air can pass through a grille or louvres.

Minimum free areas m ²	
Model	Discharge area
IPT 8	0.169
IPT 12	0.169
IPT 16ALX	0.169
IPT 16ALY	0.229
IPT 22	0.301
IPT 28	0.301

To comply with safety regulations regarding electrical installations in wet areas the heat pump must be installed at least 350cm away from the edge of the pool or spa.

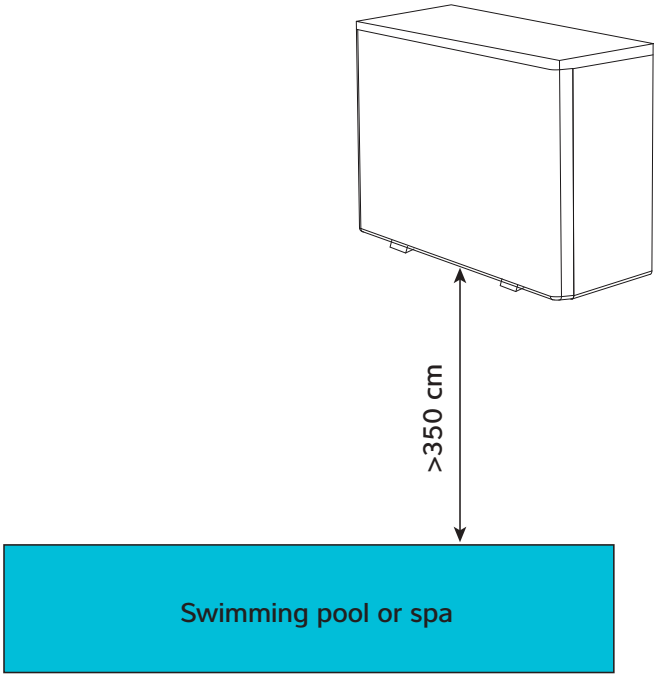

3.2 REFRIGERANT TYPE AND INSTALLED LOCATION

This heat pump contains R32, which is an environmentally friendly refrigerant with a GWP (Global Warming Potential) of 675. R32 has the safety in use classification of A2L, being low toxicity and lower flammability. In practical terms it is very difficult to ignite an A2L refrigerant, but this classification requires a risk assessment to be undertaken for the possibility of refrigerant being released by accident into an area connected to the heat pump, considering the application, location of components, and the installed refrigerant charge. This installation guidance can form the framework for such a risk assessment for the installation.

All flammable refrigerants will not ignite if the concentration level in a room stays below their lower flammability limit (LFL). European standard EN378 defines requirements to remain far below the lower flammable limit in case of accidental leakage. By choosing the location as dictated by EN378-1:2016 the probability of forming a flammable atmosphere can be eliminated. Please refer to the minimum area for each product and the interpretation below regarding locations of heat pump and swimming pool. This information is provided as a guide only and does not supersede the regulations or health and safety requirements.

Model		IPT8ALX	IPT12ALX	IPT16ALX	IPT22ALX	IPT12ALY	IPT16ALY	IPT22A/BLY	IPT28ALY
Refrigerant charge	R32 kg	0.6	0.9	1.1	2	0.9	1.2	2	2.7
Minimum area	m ²	3.1	6.9	10.3	34.0	6.9	12.3	34.0	62.0
Notes	*Assumed worst case for access category: a - general access and location class: l - mechanical equipment in occupied space; both as defined in line with EN378-1 2016 section 5.1 table 4 and section 5.3 *Minimum Area is calculated in line with section C.2 on EN378-1 2016 (calculation C.2)								

INTERPRETATION

Please refer to the installation situations below for how to apply the minimum area stated above.

Pool outside and heat pump outside:

Automatically meets the minimum area requirement because outside space is unlimited.

Pool outside and heat pump inside a plant room:

Automatically meets the minimum area requirement because the room must open to the outside for heat pump airflow and the outside space is unlimited.

Pool inside and heat pump outside:

The pool hall must exceed the minimum area requirement shown above.

Pool inside and heat pump inside a plant room, isolated from the pool hall:

The pool hall must exceed the minimum area requirement shown above.

Pool inside and heat pump inside a plant room, ventilated to the pool hall:

The pool hall and plant room combined must exceed the minimum area requirement shown above.

3.3 POOL WATER CIRCUIT

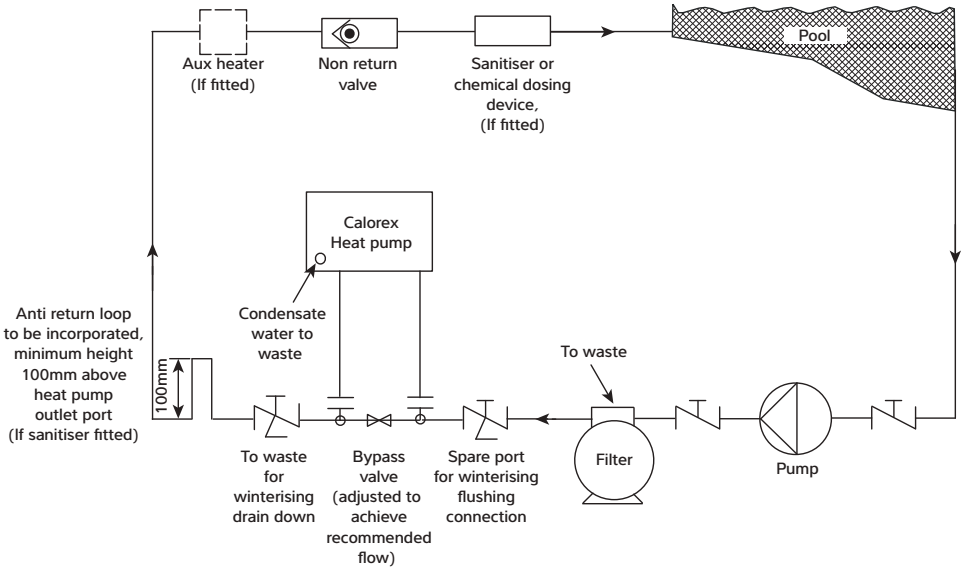

KEY	
Isolation valve	
Breakable coupling	
Three way valve	

3.4 PLUMBING

IMPORTANT

Before installing the heat pump ensure the blanking disks are removed from the pool water in/out connections. These should drop out when the adaptors are unscrewed.

1. Ensure that bypass is installed and set to achieve the recommended flow rates stated in the data sheet.
2. Ensure that the condensate drain kit supplied is fixed and is drained to a drain or soak-away.
(It is best to do this first before the heat pump is fixed to pipework or the ground).
3. Inlet and outlet pipework must be supported to avoid excessive strain on the connections.
4. Water quality must be maintained. See warranty conditions.

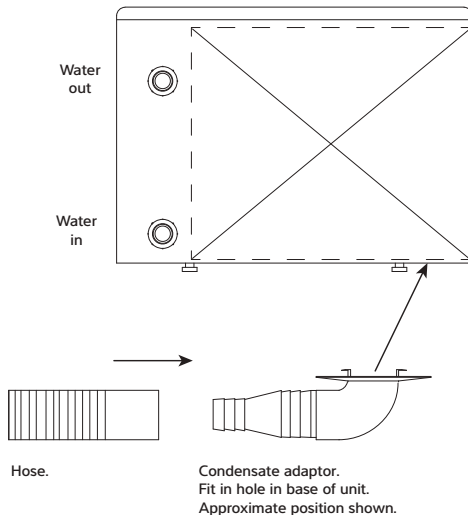
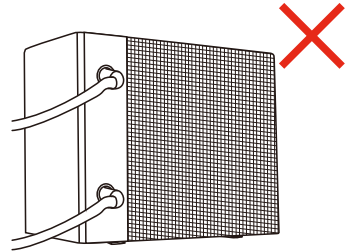
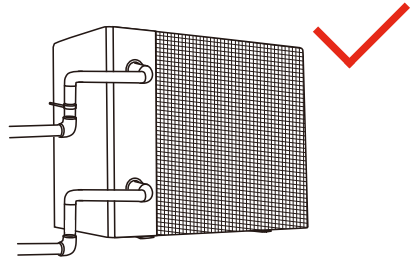

Note: Fittings shown at larger scale for clarity.

3.5 INITIAL CHECKS

Start the filtration pump before the heat pump is turned on, and turn off the heat pump before the filtration pump. It is recommended to turn off the heat pump prior to backwashing.

Before starting the heat pump, please check for any leakage of water; and check/set the required temperature on the controller, and then turn on.

In order to protect the components, the heat pump incorporates time delays. When starting heating/cooling the fan will run for one minute before the compressor starts. When the heat pump stops heating/cooling, or is turned off by the user, the fan will continue to run for one minute.

After starting up, check for any error codes or abnormal noise from the heat pump.

3.6 ELECTROLYTIC CORROSION IN SWIMMING POOLS

Electrolytic corrosion will occur when dissimilar metals that are in contact with each other create a potential difference between themselves. Sometimes separated by a conductive substance known as an electrolyte, the dissimilar metals will create a small voltage (potential difference) that allows the ions of one material to pass to the other.

Just like a battery, ions will pass from the most positive material to the more negative material.

Anything more than 0.3 volts can cause the most positive material to degrade.

A swimming pool with its associated equipment can create this effect. The pool water being an ideal electrolyte and components of the filtration circuit, heating system, steps, lights etc providing the dissimilar metals needed to complete the circuit.

Whilst these small voltages are rarely a safety threat, they can create premature failure through corrosion. Not dissimilar to corrosion through oxidation, electrolytic corrosion can cause complete failure of a metallic material in a very short period of time.

In order to prevent this type of corrosion all metallic components in contact with swimming pool water should be bonded together using 10mm² bonding cable. This includes non-electrical items such as metal filters, pump strainer boxes, heat exchangers, steps and handrails. It is highly recommended that bonding be retrofitted to existing pools, which may not be protected by this system.

3.7 ELECTRIC WIRING AND SUPPLY

All electrical work to be carried out in accordance with I.E.E. regulations, latest issue, or local codes of practice as applicable.

The machine should be installed in accordance with EMC2004/108/EC.

Always isolate the main power supply before removing machine covers.

The machine power supply must incorporate the following. Fuses or motor type circuit breakers (aM Fuse / MCB type C) to specified rating (see datasheet). When using a fuse, H.R.C. fuses are recommended. An isolator which disconnects all poles must be fitted within 2m and in line of sight of the heat pump. The isolator must have a minimum of 3mm air gap when turned off.

All units must be correctly earthed/grounded and its own separate type RCD earth leakage trip installed which protects the machine only. See data sheet for the correct type.

The following limits of operation must not be exceeded. Failure to provide the necessary voltages will invalidate the warranty. This voltage must be available at the heat pump whilst running. The voltage must not drop below the above figures when starting the compressor.

	Minimum	Maximum
Voltage		
Single phase machines	207V	253V
Three-phase machines	360V	440V
Cycle frequency (50Hz)	47.5Hz	52.5Hz

3.8 CONNECTING THE HEAT PUMP TO THE POWER SUPPLY

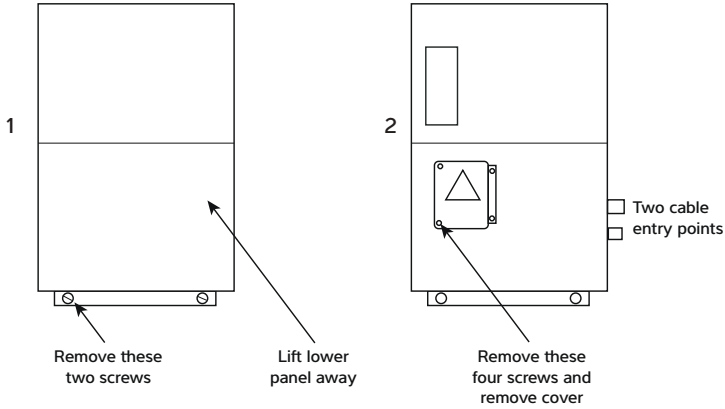

Single phase

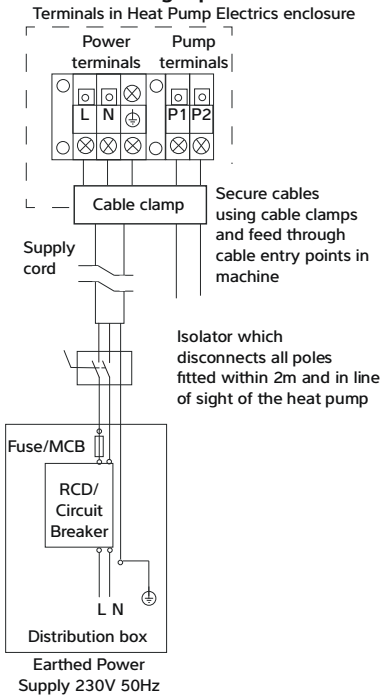

Three phase

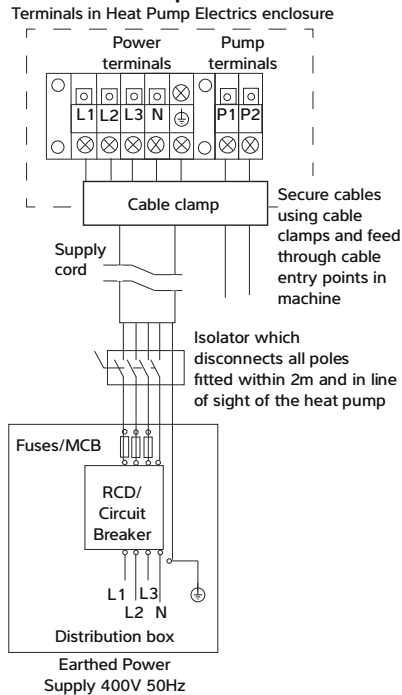

3.9 POOL PUMP SYNCHRONISATION TERMINALS P1 AND P2

For installations where the pool filter pump runs continuously, these terminals do not need to be used.

For installations where a timeclock controls the pool filter pump, and the same pump provides water flow to the heat pump, the heat pump can override "pump off" periods to ensure the pool is heated/cooled. To activate this setting please speak to your installer.

When installed in parallel with the timeclock, the pool filter pump will run when:

- a) a block period of "pump on" has been set on the time clock for filtration purposes.
- b) the heat pump runs the pool filter pump for temperature sampling and if the pool subsequently requires heating/cooling.

This feature operates by over-riding the timeclock for 3 minutes to circulate the pool water through the heat pump to sample the water temperature. The default sampling time interval is 1 hour. If the

measured temperature is more than 1°C from the set temperature, the point heat pump will continue to run the filter pump and heat/cool the pool. If the measured temperature is within 1°C of the set temperature, the filter pump will be turned off until the next sampling period, or the next timeclock "pump on" period.

When the pool pump is already running, and the heat pump is not heating/cooling, the heat pump will sample the water temperature once per hour and will start heating/cooling if needed. **The heat pump will ignore a demand to heat/cool the pool until the sampling timer (default 1 hour) has elapsed*.**

This feature will reduce the pool filter pump run time to minimise pump energy usage.

*If the pool filter pump is later changed to run continuously, it is recommended to de-activate this setting so the heat pump will respond to a heating/cooling demand without waiting for the sampling time interval to elapse. To deactivate this setting please speak to your installer.

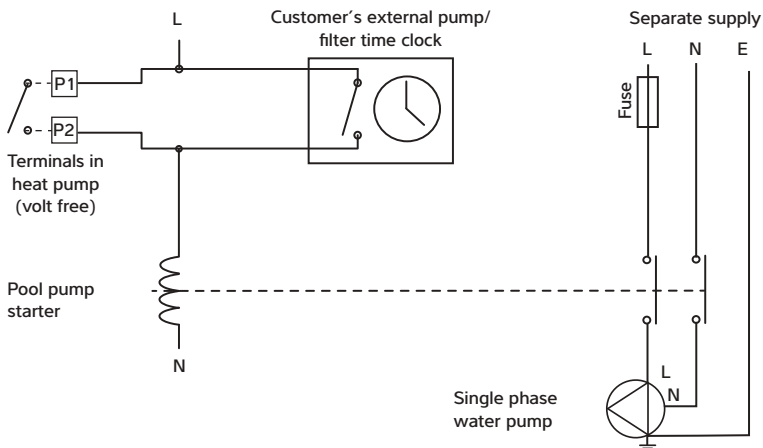

3.10 INSTALLING THE OPTIONAL REMOTE CONTROLLER

This optional accessory replaces the integral controller and can be installed up to 10m away.

Take the lid off the I-PAC to gain access to the existing controller. Remove the front cover. Disconnect the plug from the socket on the back of the controller as shown.



Feed the 10m cable through the grommet.



Remove the bulkhead connector from the position shown and replace it with a rubber grommet.



This hole.

Route the cable inside the I-PAC securing it where necessary.



Connect the lead.



Remove the two screws from the back of the Remote Controller.



Connect the lead.



Remove the appropriate knock out and fit the back of the box to the wall.

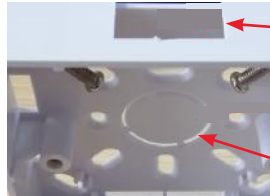

Inlet for exposed cable.

Inlet for concealed cable.

If the cable is concealed, fit the grommet in the hole to protect the cable from rubbing.

Secure the cable from the controller in the I-PAC







Refit the front cover and the top cover.

To check that the installation is correct, set the temperature on the remote controller to slightly higher than the pool water. The I-PAC should run to heat the pool, immediately if the pump synchronisation is not in use, or at the next sampling period if pump synchronisation is in use.

4.0 USING YOUR HEAT PUMP

4.1 THE KEY PAD



Symbol	Designation	Function
	On/Off	<ol style="list-style-type: none"> 1. Power On/Off 2. Wi-Fi Setting
	Lock/Unlock and Heat Mode	<ol style="list-style-type: none"> 1. Lock/Unlock Screen 2. Heating mode (18-40°C) 3. Cooling mode (12-30°C) 4. Auto mode (12-40°C)
	Speed Mode	<ol style="list-style-type: none"> 1. Boost  2. Whisper 
	Up/Down	Temperature Setting

The buttons will turn dark when the controller is locked.

4.2 OPERATING INSTRUCTIONS

IMPORTANT

Remember that at startup there is a 1 minute time delay before the heat pump starts

a. Screen lock

1) Press  for 3 seconds to lock or unlock the screen. The buttons will turn dark when the controller is locked.

2) Automatic lock period: 30 seconds if no operation.

b. Power on

Press  for 3 seconds to unlock screen.

Press  to power on the heat pump.



c. Temperature setting

Press  and  to display and adjust the set temperature.

d. Mode selection

1. Heating/Cooling/Auto

Press  to switch between heating, cooling, and automatic modes.

Mode	Symbol	Water temperature setting range
Heating		18-40°C
Cooling		12-30°C
Auto		12-40°C

e. Speed Mode selection



Press  to switch between Boost mode  and

Whisper mode. 

Default mode: Boost. 







Please choose Boost mode  for initial heating.

f. Wi-Fi

When the screen is on, press  for 3 seconds, after  flashes, enter Wi-Fi connection.

Connect Wi-Fi on mobile phone and input password, then control equipment by Wi-Fi. When APP connects Wi-Fi successfully  light is on.

g. Defrosting

1. Automatic defrosting: When the heat pump is defrosting, the  lamp flashes; after defrosting the  lamp stops flashing.
2. Forced defrosting: When the heat pump is heating and the compressor has been running continuously for at least 10 minutes, press  and  simultaneously for 5 seconds to start forced defrosting. The  lamp flashes and defrost starts, when the  lamp stops flashing defrosting stops.

The interval between forced defrosts must be more than 30 minutes.

4.3 USING THE APP

a. APP Download



Android please download from



iOS please download from



b. Account registration

1. Register by mobile or E-mail.

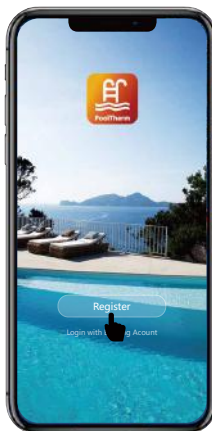

2. Mobile or E-mail registration.

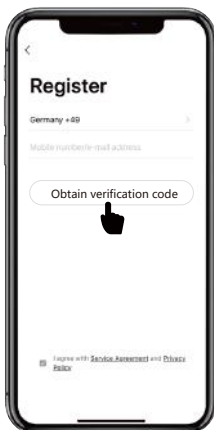



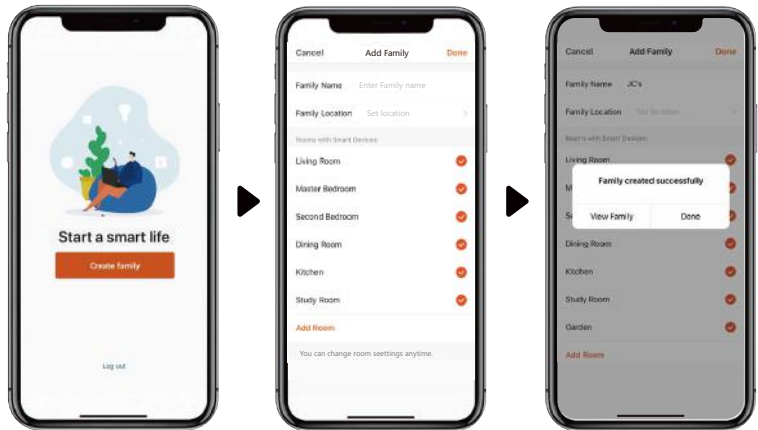

c. Create family



d. APP Pairing



Please make sure you are connected to the Wi-Fi.

1. Press “” for three seconds to unlock the screen.
2. Press “” for three seconds then release, after hearing the beep, enter the Wi-Fi code. During connection the “” flashes. When the APP connects to the Wi-Fi successfully the “” light will come on.

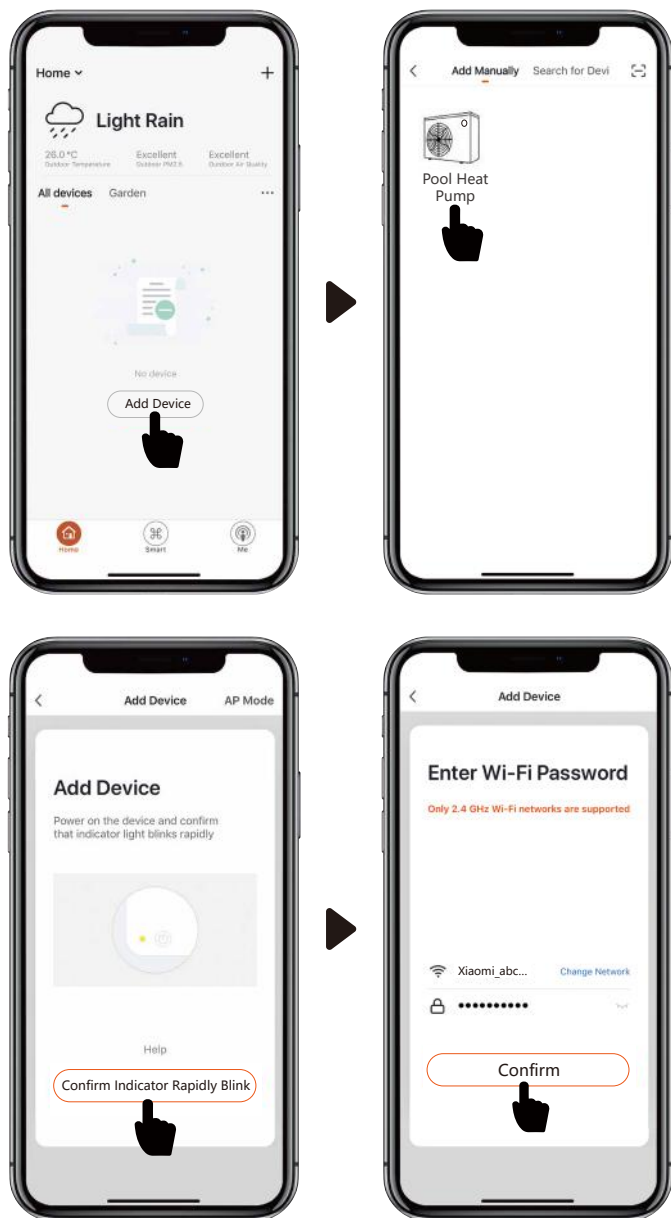

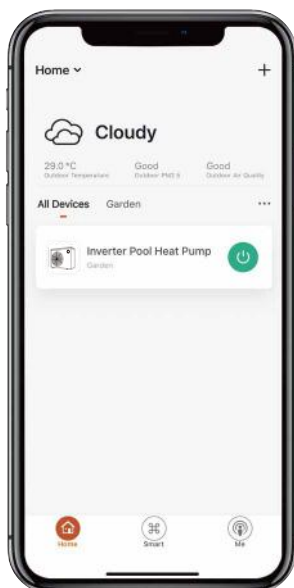
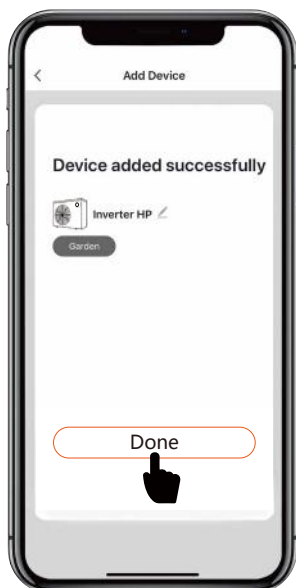

e. Operation

1. For heat pump with Heating function only :



2. For heat pump with Heating and Cooling function :

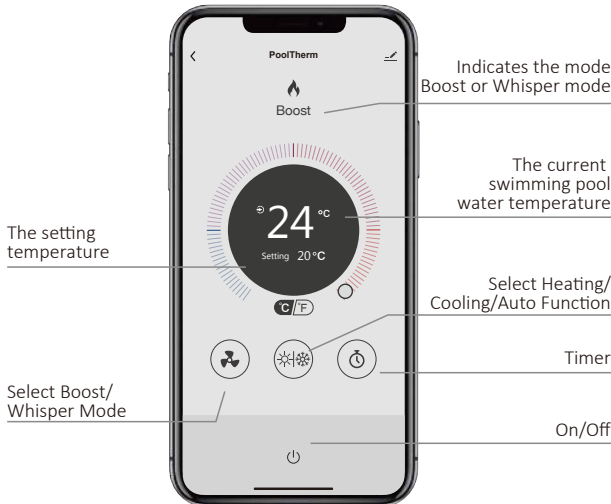

f. Share devices to your family members

After pairing, if your family members also want to control the device.

Please let your family members register the APP first, and then the administrator can operate as below:

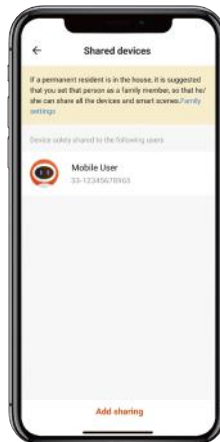
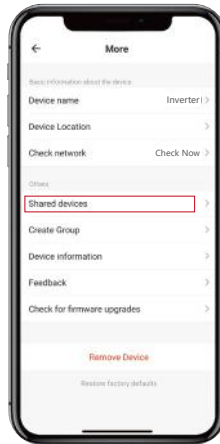

Notes:





1. The weather forecast is just for reference.

App is subject to updating without notice.

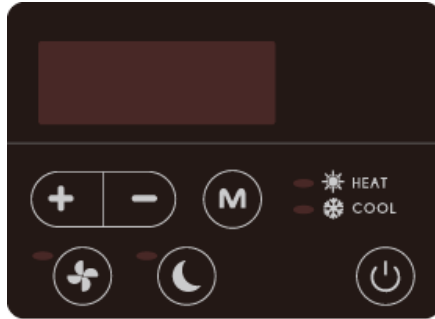
4.4 USING THE OPTIONAL REMOTE CONTROLLER

4.5 THE KEY PAD

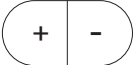

Symbol	Function
	Power On/Off
	Heating/Cooling/Auto mode
	Press to start Boost mode
	Press to start Whisper mode
	Temperature setting and display.

4.6 OPERATING INSTRUCTIONS

a. Power On & Power Off

Press  to power on or power off the heat pump.

b. Temperature Setting

Press  to display and adjust temperature.

c) Mode selection

1. Heating/Cooling/Auto modes

Press  to choose heating, cooling and automatic mode.

In heating mode the  light is on.

In cooling mode the  light is on.

In automatic mode the  and  the lights are on.

2. Whisper and Boost modes



Press  to start Boost mode, and light will turn on.

Press  to start Whisper mode, and light will turn on. (Default mode is Boost).





Please choose Boost mode  for initial heating.

c. Defrosting

1. Automatic defrosting

When machine is defrosting, the  lamp flashes; after defrosting the  lamp is illuminated.

2. Forced defrosting

When the heat pump is heating and the compressor has been working continuously for at least 10 minutes, press  and  on the touchscreen controller simultaneously for 5 seconds to start forced defrosting. The  lamp flashes and defrost starts, when the  lamp stops flashing defrosting stops.

The interval between forced defrosts must be more than 30 minutes.

5.0 TESTING

Inspect the heat pump before use

- Check that the fan, air inlets and outlets are not obstructed.
- It is prohibited to install refrigeration pipe or components in corrosive environment.
- Check that the electric wiring conforms to the electric wiring diagram and that the machine is earthed.
- Double check that the main power switch is off.
- Check the temperature setting.

5.1 HEAT PUMP MALFUNCTION

WARNING: Isolate heat pump electrically, and wait 3 minutes before removing panels or entering heat pump.

- Refer to the user check list in section 5.2 and the error codes listed in section 5.3 before initiating a service call.
- Do not attempt to interfere with any internal control settings as these have been factory calibrated and sealed.
- Any sign of abnormal operation such as water dripping should be reported immediately to the installer. If in doubt or if advice is required contact the Service support team on telephone +44(0)1621 8566 11 (option 4).

Fault	Reason	Solution
Heat pump doesn't run	No power	Wait until the power is restored
	Power is switched off	Switch on the power
	Fuse has blown	Check and change the fuse
	The breaker is off	Check and turn on the breaker
Fan running but with insufficient heating	Evaporator blocked	Remove the obstructions
	Air outlet blocked	Remove the obstructions
	Compressor start delay	Wait for the delay timer to time out
Display normal, but no heating	Set temperature too low	Set desired heating temperature
	Start delay	Wait for the delay timer to time out
Inaccurate switch action	Stop the machine, and cut off the power supply immediately, then contact your dealer	
The fuse blows frequently or leakage circuit breaker trips frequently		

If above solutions don't work, please contact your installer with detailed information and your model number. Don't try to repair it yourself.

5.2 PROTECTION CODES

These codes indicate machine stopping due to external circumstances.

These are not faults with the heat pump.

No	Display	Reason	Solution
1	E3	No water flow through the heat pump.	Check water circuit and pool pump.
2	E4	Three phase rotation protection.	Check phases connected correctly (Electrician required)
3	E5	Voltage of power supply to heat pump is out of range.	Check the power supply.
4	E6	Low water flow indicated by more than 10°C difference in inlet and outlet temperature.	Check water flow and pool pump.
5	Eb	Ambient temperature is out of range, either lower than -5°C (-10°C Y version) or higher than 43°C.	If outside, wait for ambient conditions to improve (winterisation may be required). If installed in a sheltered place, check for air recirculation.
5	Ed	Frost protection. The heat pump runs in heating mode for a short time when in standby mode to prevent frost build up. This does not replace winterisation.	Heat pump will resume standby once process is completed.

5.3 FAULT CODES

**When the heat pump displays these error codes
please contact your installer for advice.**

No	Display	Description of fault code
1	E1	High pressure alarm
2	E2	Low pressure alarm
4	E7	Water outlet temp out of range alarm
5	E8	High exhaust temp alarm
6	EA	Evaporator overheat alarm (only in cooling mode)
7	P0	Controller communication failure
8	P1	Water inlet temp sensor failure
9	P2	Water outlet temp sensor failure
10	P3	Gas exhaust temp sensor failure
11	P4	Evaporator coil pipe temp sensor failure
12	P5	Gas return temp sensor failure
13	P6	Cooling coil pipe temp sensor failure
14	P7	Ambient temp sensor failure
15	P8	Cooling plate sensor failure
16	P9	Current sensor failure
17	PA	Restart memory failure
18	F1	Compressor drive module failure
19	F2	PFC module failure
20	F3	Compressor start failure
21	F4	Compressor running failure
22	F5	Inverter board over current protection
23	F6	Inverter board overheat protection
24	F7	Current protection
25	F8	Cooling plate overheat protection
26	F9	Fan motor failure
27	Fb	Power filter plate - no power protection
28	FA	PFC module over current protection

6.0 MAINTENANCE



Isolate the power supply of the heat pump and wait 3 Minutes before cleaning, examination or repair.

Cover the heat pump body when not in use.

Please clean this machine with household detergents or clean water, NEVER use petroleum spirit, thinners or any similar fuel.

Check bolts, cables and connections regularly.

Repair, service and disposal of redundant heat pumps must be completed by authorised technicians. It is illegal to allow refrigerant gases to escape to air.

Do not attempt to work on the equipment by yourself. Improper operation may cause danger.

7.0 TROUBLE SHOOTING COMMON FAULTS



Requirements for service personnel

Any person who is involved with working on or breaking into a refrigerant circuit should hold a current valid certificate from an industry-accredited assessment authority, F-Gas registered.

Do not attempt to work on the equipment by yourself.

OWNER/INSTALLATION MANUAL

8.0 DATASHEETS

MODEL	UNITS	IPT8 ALX	IPT12 ALX	IPT16 ALX	IPT22 ALX
PERFORMANCE CONDITION: Air 27°C/Water 27°C/RH 80%					
Heating capacity	kW	9.5	13.0	20.0	25.0
COP range		13.2-5.4	13.5-5.6	13.5-5.7	13.8-5.8
Average COP at 50% Speed		8.9	9.7	9.3	9.6
PERFORMANCE CONDITION: Air 15°C/Water 26°C/RH 70%					
Heating capacity	kW	7.0	9.5	13.5	17.0
COP range		6.9-4.2	7.0-4.0	7.0-4.2	7.2-4.0
Average COP at 50% Speed		6.3	6.1	6.3	6.4
PERFORMANCE CONDITION: Air 35°C/Water 28°C/RH 80%					
Cooling capacity (kW)		3.9	5.2	7.4	9.4
TECHNICAL SPECIFICATIONS					
Operating air temperature	°C	-5°C to 43°C			
Water heating setting range	°C	18°C to 40°C			
Water cooling setting range	°C	12°C to 30°C			
POWER SUPPLY					
230V Single Phase 50Hz					
Rated input power	kW	0.3-1.79	0.40-2.38	0.57-3.21	0.69-4.25
Rated input current	A	1.38-7.58	1.82-10.8	2.60-14.61	3.16-19.32
Maximum input current	A	9.5	12.5	19.5	20
Rated RCD type F	mA	30	30	30	30
Rated Fuse aM / MCB type C	A	16	16	25	25
Sound pressure level at 10m	dB(A)	19.6-31.5	21.9-32.0	24.3-36.1	24.9-36.7
Recommended water flow rate	m³/h	3.0-5.0	4.0-6.0	7.0-10.0	10.0-12.0
Pressure drop	m/kPa	0.36/3.5	0.41/4.0	0.56/5.5	0.77/7.5
Pool water connections	Inches	1½" or 50mm Female			
GENERAL DATA					
Net dimensions (w x d x h)	mm	864 x 359 x 648	864 x 359 x 648	954 x 359 x 748	1084 x 429 x 948
Packed dimensions (w x d x h)	mm	950 x 375 x 675	950 x 375 x 675	1040 x 375 x 775	1130 x 445 x 985
Net weight	kg	47	49	68	90
HERMETIC SYSTEM					
Refrigerant charge R32	kg	0.6	0.9	1.1	2.0
Minimum area requirement	m2	3.1	6.9	10.3	34.0

NOTES: Heat pump performance parameters are subject to change without notice. Always refer to the nameplate.
Global warming potential (GWP) R32 - 675.

The data is subject to modification without prior warning.

MODEL	UNITS	IPT 12 ALY	IPT16 ALY	IPT22 ALY
PERFORMANCE CONDITION: Air 27°C/Water 27°C/RH 80%				
Heating capacity	kW	15.0	21.0	27.5
COP range		15.0-6.6	14.8-6.4	15.0-6.5
Average COP at 50% Speed		10.6	10.3	10.3
PERFORMANCE CONDITION: Air 15°C/Water 26°C/RH 70%				
Heating capacity	kW	10.5	14.5	18.0
COP range		7.7-4.6	7.1-4.6	7.5-4.6
Average COP at 50% Speed		6.4	6.3	6.3
PERFORMANCE CONDITION: Air 35°C/Water 28°C/RH 80%				
Cooling capacity	kW	6.7	9.5	11.9
TECHNICAL SPECIFICATIONS				
Operating air temperature	°C	-10°C to 43°C		
Water heating setting range		18°C to 40°C		
Water cooling setting range		12°C to 30°C		
POWER SUPPLY		230V Single Phase 50Hz		
Rated input power	kW	0.27-2.28	0.41-3.15	0.48-3.91
Rated input current	A	1.17-9.91	1.78-13.69	2.08-17.00
Maximum input current	A	13.5	17	20
Rated RCD type F	mA	30	30	30
Rated Fuse aM / MCB type C	A	20	25	25
Sound pressure level at 10m	dB(A)	20.8-24.5	20.4-33.7	23.0-34.4
Recommended water flow rate	m ³ /h	5.0-7.0	8.0-10.0	10.0-12.0
Pressure drop	m/kPa	0.49/4.8	0.61/6.0	0.77/7.5
Pool water connections	Inches	1½" or 50mm Female		
GENERAL DATA				
Net dimensions (w x d x h)	mm	954x359x648	954x429x755	1084x429x948
Packed dimensions (w x d x h)	mm	1040x445x655	1040x445x655	1130x445x985
Net weight	kg	52	68	90
HERMETIC SYSTEM				
Refrigerant charge R32	kg	0.9	1.2	2.0
Minimum area requirement	m ²	6.9	12.3	34.0

NOTES: Heat pump performance parameters are subject to change without notice. Always refer to the nameplate.
Global warming potential (GWP) R32 - 675.

The data is subject to modification without prior warning.

OWNER/INSTALLATION MANUAL

MODEL	UNITS	IPT16 BLY	IPT22 BLY	IPT28 BLY
PERFORMANCE CONDITION: Air 27°C/Water 27°C/RH 80%				
Heating capacity	kW	21.0	27.5	36.0
COP range		14.8-6.4	15.0-6.8	14.8-6.0
Average COP at 50% Speed		10.3	10.3	10.2
PERFORMANCE CONDITION: Air 15°C/Water 26°C/RH 70%				
Heating capacity	kW	14.5	18.0	23.9
COP range		7.1-4.6	7.5-4.6	7.5-4.6
Average COP at 50% Speed		6.3	6.3	6.3
PERFORMANCE CONDITION: Air 35°C/Water 28°C/RH 80%				
Cooling capacity	kW	9.5	11.9	16.0
TECHNICAL SPECIFICATIONS				
Operating air temperature	°C	-10°C to 43°C		
Water heating setting range		18°C to 40°C		
Water cooling setting range		12°C to 30°C		
Power supply		400V Three Phase 50Hz		
Rated input power	kW	0.41-3.15	0.48-3.91	0.64-5.20
Rated input current	A	0.59-4.56	0.69-5.66	0.92-7.53
Maximum input current	A	5.8	7	9.5
Rated RCD type B	mA	30	30	30
Rated Fuse aM / MCB type C	A	10	10	16
Sound pressure level at 10m	dB(A)	20.4-33.7	23.0-34.4	22.1-34.2
Recommended water flow rate	m ³ /h	8.0-10.0	10.0-12.0	12.0-18.0
Pressure drop	m/kPa	0.61/6.0	0.77/7.5	0.85/8.5
Pool water connections	Inches	1½" or 50mm Female		
GENERAL DATA				
Net dimensions (w x d x h)	mm	954x429x755	1084x429x948	1154x539x948
Packed dimensions (w x d x h)	mm	1040x445x655	1130x445x985	1200x555x985
Net weight	kg	68	93	120
HERMETIC SYSTEM				
Refrigerant charge R32	kg	1.2	2.0	2.7
Minimum area requirement	m ²	12.3	34.0	62.0

NOTES Heat pump performance parameters are subject to change without notice. Always refer to the nameplate. Global warming potential (GWP) R32 - 675.

The data is subject to modification without prior warning.

9.0 DIMENSIONS

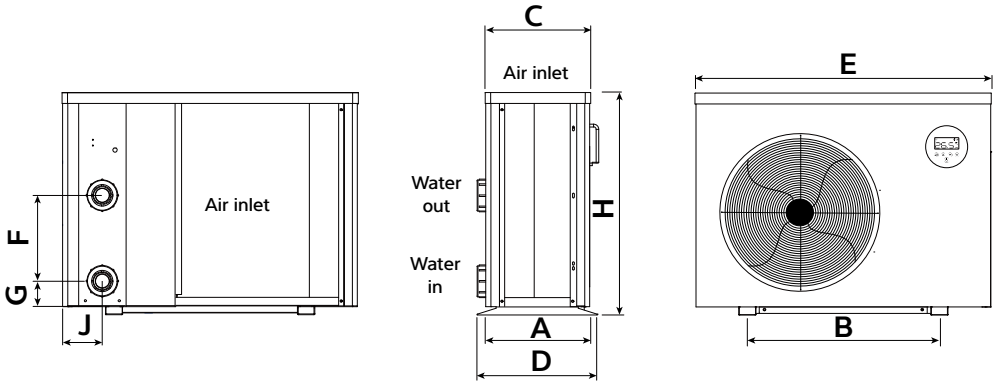

	A	B	C	D	E	F	G	H	J
IPT8 ALX	334	560	318	359	864	250	74	648	116
IPT12 ALX	334	560	318	359	864	290	74	648	116
IPT16 ALX	334	590	318	359	954	390	74	748	116
IPT22 ALX	404	720	388	429	1084	640	74	948	107

	A	B	C	D	E	F	G	H	J
IPT12 ALY	334	590	318	359	954	340	74	648	107
IPT16 ALY	404	590	388	429	954	460	74	755	107
IPT16 BLY	404	590	388	429	954	460	74	755	107
IPT22 ALY	404	720	388	429	1084	620	74	948	107
IPT22 BLY	404	720	388	429	1084	620	74	948	107
IPT28 BLY	514	790	498	539	1154	650	74	948	128

9.1 DIMENSIONS

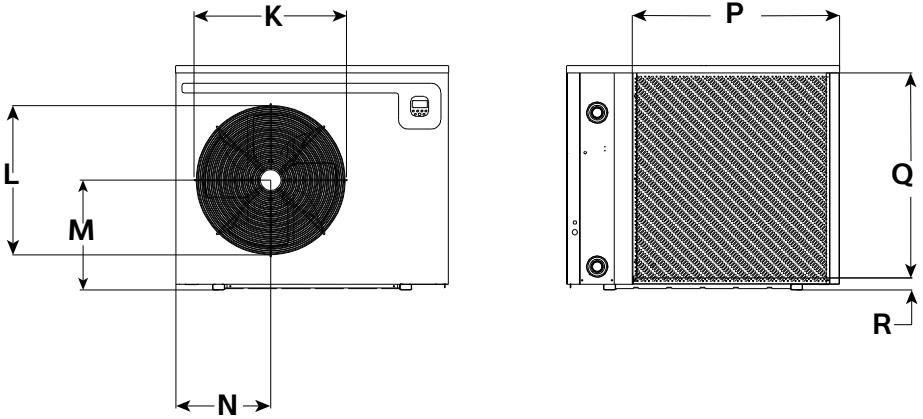

	K	L	M	N	P	Q	R
IPT8 ALX	478	465	285	288	533	565	50
IPT12 ALX	478	465	285	288	630	565	50
IPT16 ALX	478	465	349	315	675	666	50
IPT22 ALX	645	630	462	405	799	861	50

	K	L	M	N	P	Q	R
IPT12 ALY	478	465	300	349	743	566	50
IPT16 ALY	587	540	370	349	731	667	50
IPT16 BLY	587	540	370	349	731	667	50
IPT22 ALY	645	630	462	405	799	861	50
IPT22 BLY	645	640	462	405	799	861	50
IPT28 BLY	645	630	462	400	876	866	50

10.0 WINTERISATION PROCEDURE

WARNING. Isolate machine before opening! As heat pump embodies electrical and rotational equipment, it is recommended for your own safety that a competent person carries out the following procedure.

(Drain Down Procedure)

ALL MODELS

Objective

To provide frost protection

To eliminate corrosion problems

To inhibit electrical components

1. Switch off electrical supply to heat pump.
2. Remove external fuses and keep in safe place away from heat pump to prevent accidental operation of heat pump.
3. Ensure water circulation pump is switched off.
4. Drain water from heat pump by:
 - a) Drain valve if fitted.
 - b) Disconnecting pipework to and from heat pump.
 - c) Remove condenser drain down cover.
 - d) Flush through water circuit in heat pump by using CLEAN TAP WATER (NOT POOL WATER) via hose into outlet connection – run for 10 minutes minimum, use spray nozzle if available.
 - e) Allow to drain – fit plastic bags secured by elastic bands over water connections.
5. Uncover electrical enclosure (page 18) and liberally spray interior of unit, with moisture repellent aerosol WD-40 or similar, reseal enclosure.
6. If heat pump located outside, protect from weather by covering with VENTILATED cover. A bespoke cover is available. Do not use plastic sheet as condensation can occur within unit.

If this procedure is not adopted and frost or corrosion damage results then the warranty will become invalid.

10.1 START UP PROCEDURE AFTER WINTERISATION

1. Replace covers (if not fitted).
2. Remove front grille – using soft brush clean finned surfaces of heat pump. Replace panel.
3. Remove plastic covers on water connections and reconnect water piping or close drain valve.
4. Start up water circulating pump and leave running for at least ¼ hour to establish flow and enable any air in system to escape.
5. Replace fuses to heat pump circuit.
6. Switch on heat pump.
7. Check control thermostat is set to required pool temperature.
8. Check daily to ensure pool water is at correct pH and has correct chemical balance. See section 11.0 Warranty conditions.

11.0 WARRANTY CONDITIONS

The following exclusions apply to the warranty given by Dantherm Ltd. No claims will be accepted if:

1. The heat pump is installed in any way that is not in accordance with the current procedures as defined by Dantherm Ltd.
2. The heat pump has been worked upon or is adjusted by anyone other than a person authorised to do so by Dantherm Ltd.
3. The heat pump is incorrectly sized for the application.
4. The water flow through the machine is outside the specified limits.
5. The water pH level and/or chemical balance is outside the following limits:

Acidity pH	pH	7.2 - 7.8
Total Alkalinity, as CaCO ₃	ppm	80 - 120
Total Hardness, as CaCO ₃	ppm	150 - 250
Total Dissolved Solids	ppm	1000
Maximum Salt Content	ppm	35000
Free Chlorine Range	ppm	1 - 2 Domestic
Free Chlorine Range	ppm	3 - 6 Commercial
Superchlorination	max	30ppm for 24 hrs
Bromine	ppm	2 - 5
Baquacil	ppm	25 - 50
Ozone	ppm	0.9 Max
Maximum Copper Content	ppm	1
Aquamatic Ionic Purifier	ppm	2 Max

6. The heat pump has suffered frost damage.
7. The electrical supply is insufficient or in any way incorrect.

8. The fan amps and duct pressure are outside the specified limits.
9. The air flow to and from the machine is outside the specified limits.

If in doubt or if advice is required please contact the Dantherm Group UK Service Department by calling +44 (0)1621 856 611 (option 4) or email service.department@dantherm.com

Please give **MODEL NUMBER** and **SERIAL NUMBER** of your heat pump when making technical or service enquiries. This will assist in correct diagnosis and ensure service can be provided with the minimum delay.

12.0 DECLARATION OF CONFORMITY

Dantherm Ltd.
Unit 12, Galford Road
Maldon CM9 4XD
United Kingdom

+44 (0)1621 856611
sales.uk@dantherm.com
danthermgroup.co.uk
VAT: GB 273 5572 21

DECLARATION OF CONFORMITY

We hereby certify that the following Dantherm models:

IPT8A, IPT12A, IPT16A, IPT22A, IPT16B, IPT22B, IPT28B range of electrically driven refrigeration heat pumps.

Conforms with

BS EN 60335-1:2012+A13:2017, BS EN 60335-2-40:2015, BS 62233:2008 and therefore comply with the Low Voltage Electrical Equipment Directive 2014/35/EU and the essential safety requirements of the Machinery Directive 2006/42/EC.

Conforms with

BS EN 55014-1:2017, BS EN 55014-2:2015, BS EN 61000-3-2:2014, BS EN61000-3-3:2013 and therefore comply with the Electromagnetic Compatibility Directive 2014/30/EU.

Compliant to RoHS Directive 2011/65/EC amended by Directive [EU] 2015/863

Falls outside the scope of the WEEE directive.

Don Kempster
Finance Director

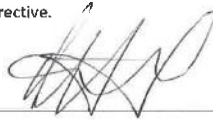

Date 28-05-2020



AERIAL

 **calorex**

Dantherm

MASTER

CEC 010 149 Rev. 05/08/2016

Dantherm Ltd.

Unit 12, Galliford Road
Maldon CM9 4XD
United Kingdom
+44 (0)1621 856 611
sales.uk@dantherm.com